

MS-98F6

Industrial Computer Board



Copyright and Trademarks Notice

Copyright © Micro-Star Int'l Co., Ltd. All rights reserved. The MSI logo used is a registered trademark of Micro-Star Int'l Co., Ltd. All other marks and names mentioned may be trademarks of their respective owners. No warranty as to accuracy or completeness is expressed or implied. MSI reserves the right to make changes to this document without prior notice.

Revision History

Revision	Date
V1.2	2018/08

Technical Support

If a problem arises with your product and no solution can be obtained from the user's manual, please contact your place of purchase or local distributor. Alternatively, please visit <https://www.msi.com/support/> for further guidance.

Safety Instructions

- Always read the safety instructions carefully.
- Keep this User's Manual for future reference.
- Keep this equipment away from humidity.
- Lay this equipment on a reliable flat surface before setting it up.
- The openings on the enclosure are for air convection hence protects the equipment from overheating. **DO NOT COVER THE OPENINGS.**
- Make sure the voltage of the power source and adjust properly 110/220V before connecting the equipment to the power inlet.
- Place the power cord such a way that people can not step on it. Do not place anything over the power cord.
- Always Unplug the Power Cord before inserting any add-on card or module.
- All cautions and warnings on the equipment should be noted.
- Never pour any liquid into the opening that could damage or cause electrical shock.
- If any of the following situations arises, get the equipment checked by service personnel:
 - The power cord or plug is damaged.
 - Liquid has penetrated into the equipment.
 - The equipment has been exposed to moisture.
 - The equipment does not work well or you can not get it work according to User's Manual.
 - The equipment has dropped and damaged.
 - The equipment has obvious sign of breakage.
- **DO NOT LEAVE THIS EQUIPMENT IN AN ENVIRONMENT UNCONDITIONED, STORAGE TEMPERATURE ABOVE 60°C (140°F), IT MAY DAMAGE THE EQUIPMENT.**

警告使用者:

此為甲類資訊技術設備，於居住環境中使用時，可能會造成射頻擾動，在此種情況下，使用者會被要求採取某些適當的對策。

Chemical Substances Information

In compliance with chemical substances regulations, such as the EU REACH Regulation (Regulation EC No. 1907/2006 of the European Parliament and the Council), MSI provides the information of chemical substances in products at:

https://www.msi.com/html/popup/csr/evmtrptt_pcm.html

Battery Information



European Union:

Batteries, battery packs, and accumulators should not be disposed of as unsorted household waste. Please use the public collection system to return, recycle, or treat them in compliance with the local regulations.



Taiwan:

For better environmental protection, waste batteries should be collected separately for recycling or special disposal.

廢電池請回收

California, USA:

The button cell battery may contain perchlorate material and requires special handling when recycled or disposed of in California.

For further information please visit:

<https://www.dtsc.ca.gov/hazardouswaste/perchlorate/>

Danger of explosion if battery is incorrectly replaced. Replace only with the same or equivalent type recommended by the manufacturer.

CE Conformity

Hereby, Micro-Star International CO., LTD declares that this device is in compliance with the essential safety requirements and other relevant provisions set out in the European Directive.



FCC-A Radio Frequency Interference Statement



This equipment has been tested and found to comply with the limits for a Class A digital device, pursuant to Part 15 of the FCC Rules. These limits are designed to provide reasonable protection against harmful interference when the equipment is operated in a commercial environment. This equipment generates, uses and can radiate radio frequency energy and, if not installed and used in accordance with the instruction manual, may cause harmful interference to radio communications. Operation of this equipment in a residential area is likely to cause harmful interference, in which case the user will be required to correct the interference at his own expense.

Notice 1

The changes or modifications not expressly approved by the party responsible for compliance could void the user's authority to operate the equipment.

Notice 2

Shielded interface cables and AC power cord, if any, must be used in order to comply with the emission limits.

This device complies with Part 15 of the FCC Rules. Operation is subject to the following two conditions:

- 1) this device may not cause harmful interference, and
- 2) this device must accept any interference received, including interference that may cause undesired operation.

WEEE Statement



Under the European Union ("EU") Directive on Waste Electrical and Electronic Equipment, Directive 2002/96/EC, which takes effect on August 13, 2005, products of "electrical and electronic equipment" cannot be discarded as municipal waste anymore and manufacturers of covered electronic equipment will be obligated to take back such products at the end of their useful life. MSI will comply with the product take back requirements at the end of life of MSI-branded products that are sold into the EU. You can return these products to local collection points.

CONTENTS

Copyright and Trademarks Notice.....	ii
Revision History	ii
Technical Support.....	ii
Safety Instructions.....	iii
Chemical Substances Information	iv
Battery Information	iv
CE Conformity.....	v
FCC-A Radio Frequency Interference Statement	v
WEEE Statement	v
1. Overview.....	1-1
Motherboard Specifications.....	1-2
Motherboard Layout.....	1-4
ME Overview.....	1-5
2. Hardware Setup	2-1
Memory	2-3
Power Supply.....	2-4
Rear Panel I/O	2-5
Connector.....	2-7
Jumper	2-15
Slot.....	2-18
3. BIOS Setup.....	3-1
Entering Setup	3-2
The Menu Bar	3-4
Main	3-5
Advanced	3-6
Boot.....	3-12
Security	3-13
Chipset	3-17
Power.....	3-18
Save & Exit.....	3-20
Appendix WDT & GPIO	A-1
WDT Sample Code	A-2
GPIO Sample Code	A-3

1 Overview

Thank you for choosing the MS-98F6, an excellent industrial computer board.

With low power and low profile design, the MS-98F6 accommodates the Intel® Celeron® J1900/ N2930 Processor and supports up to 1 DDR3L 1333 MHz SO-DIMM slots to provide the maximum of 8GB memory capacity.

In the entry-level and mid-range market segment, MS-98F6 provides a high-performance solution for today's front-end and general purpose workstation, as well as in the future.

Motherboard Specifications

Processor

- Intel Celeron J1900/ N2930 Processor

Memory

- 1 x DDR3L 1333 MHz SO-DIMM slot
- Supports the maximum of 8GB

LAN

- 2 x Intel I210-AT GbE LAN

SATA

- 1 x SATA 3Gb/s port
- 1 x mSATA slot (shared with Mini-PCIe slot)

Audio

- Realtek ALC887 audio codec
- 1 x front audio pin header
- 1 x amplifier pin header

Graphics

- Graphics integrated in Intel processor
- 1 x VGA port
- 1 x HDMI port
- 1 x LVDS connector

Rear Panel I/O

- 1 x VGA port
- 1 x HDMI port
- 3 x USB 2.0 ports
- 1 x USB 3.0 port
- 2 x Gigabit LAN ports

Onboard Pin Headers/ Connectors/ Jumpers

- 1 x SATA connector
- 1 x SATA power connector
- 2 x USB2.0 headers
- 1 x 8-bit GPIO header
- 6 x COM port headers
- 1 x Front panel connector
- 1 x System Fan connector
- 1 x LVDS connector
- 1 x LVDS inverter connector
- 1 x LPC debug port connector
- 1 x DC power connector
- 1 x DIMM socket
- 1 x Audio connector
- 1 x Amplifier connector
- 1 x ATX/AT selection jumper
- 1 x SMBUS connector
- 1 x PS/2 keyboard/mouse connector

Slot

- 2 x Mini-PCIe slots (including 1 x mSATA function)

Form Factor

- Form Factor: 102mm x 146mm

Environmental

- Operating Temperature: -10°C ~ 60°C
- Storage Temperature: -20°C ~ 80°C
- Humidity: 10% ~ 90% RH, Non-Condensing

Motherboard Layout

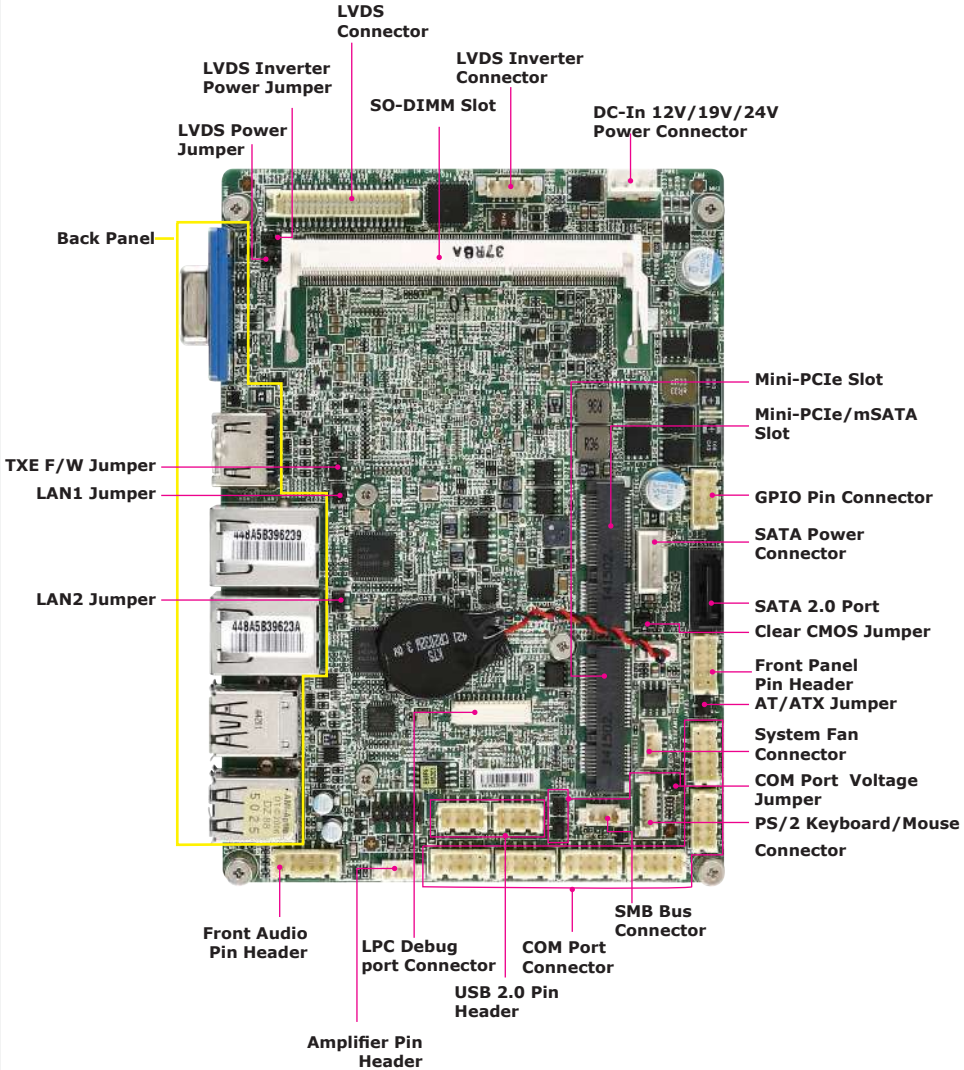

ME Overview

► Board Dimension

unit of measurement: mm

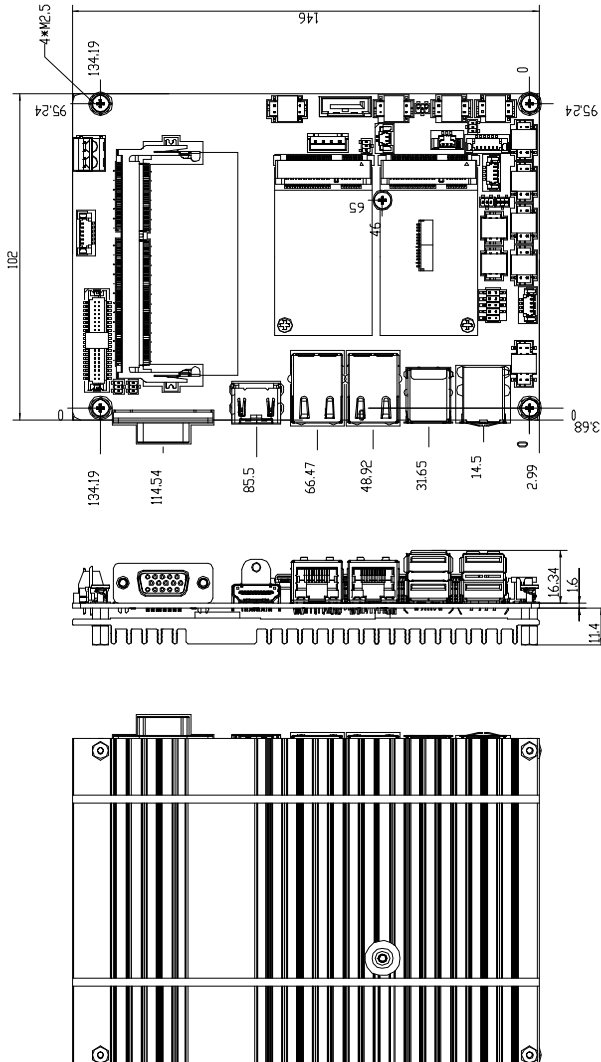

➤ **Suggested Chassis I/O Gap Dimension**

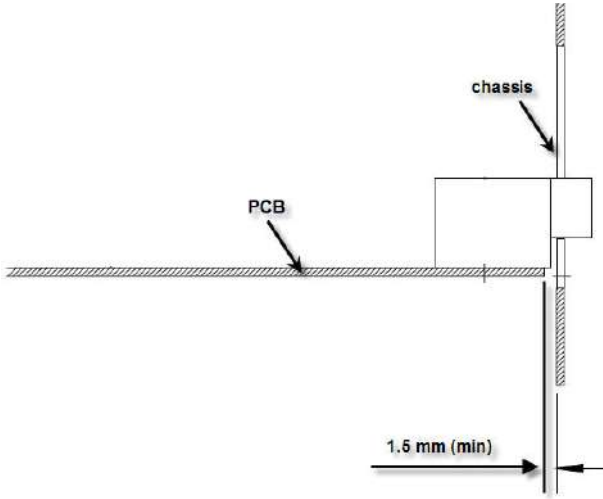

2 Hardware Setup

This chapter provides you with the information about hardware setup procedures. While doing the installation, be careful in holding the components and follow the installation procedures. For some components, if you install in the wrong orientation, the components will not work properly.

Use a grounded wrist strap before handling computer components. Static electricity may damage the components.

Components Reference Guide

Memory	2-3
Power Supply	2-4
DC Power Connector: JPWR2.....	2-4
SATA Power Connector: JPW1.....	2-4
Rear Panel I/O	2-5
Connector	2-7
Fan Power Connector: SYSFAN1.....	2-7
GPIO Pin Header: JGPIO1.....	2-8
Serial ATA Connector: SATA1.....	2-8
Front Panel Connector: JFP1.....	2-9
LPC Debug Port Connector: JDP1.....	2-9
USB 2.0 Connector: JUSB1, JUSB2.....	2-10
Serial Port Connector: COM1 ~ COM6.....	2-10
LVDS Inverter Connector: JINVDD1.....	2-12
LVDS Connector: JLVDS1.....	2-12
Audio Amplifier Pinheader: JAMP1.....	2-13
Front Audio Connector: JAUD1.....	2-13
PS/2 Keyboard/Mouse Connector: JKBMS1.....	2-14
SMBus Connector: JSMB1.....	2-14
Jumper	2-15
Clear CMOS Jumper: JCMOS1.....	2-15
AT/ATX Select Jumper: JATX1.....	2-15
Serial Port Power Jumper: JCOMP1~3.....	2-16
LAN Configure Jumper: JLAN1~2.....	2-16
LVDS Power Jumper: JVDD1.....	2-17
LVDS Inverter Power Jumper: JINV1.....	2-17
TXE F/W Jumper: JME1.....	2-17
Slot	2-18
Mini-PCIe (Peripheral Component Interconnect Express) Slot.....	2-18

Memory

The SO-DIMM slot is intended for memory modules.

1. Locate the SO-DIMM slot. Align the notch on the DIMM with the key on the slot and insert the DIMM into the slot.

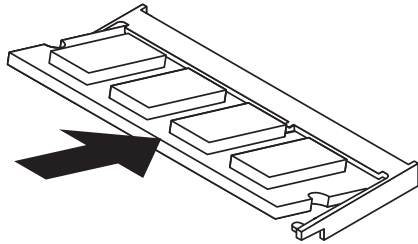

2. Push the DIMM gently downwards until the slot levers click and lock the DIMM in place.

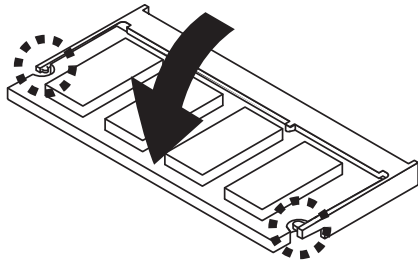

3. To uninstall the DIMM, flip the slot levers outwards and the DIMM will be released instantly.

Important

You can barely see the golden finger if the DIMM is properly inserted in the DIMM slot.

Power Supply

DC Power Connector: JPWR2

This connector allows you to connect a 12V/ 19V/ 24V DC power adapter.

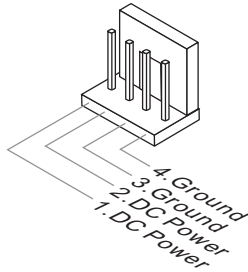

SATA Power Connector: JPW1

This connector is used to provide power to SATA devices.

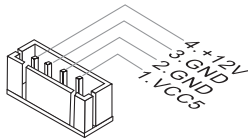

Important

Make sure that all power connectors are connected to the power supply to ensure stable operation of the motherboard.

Rear Panel I/O

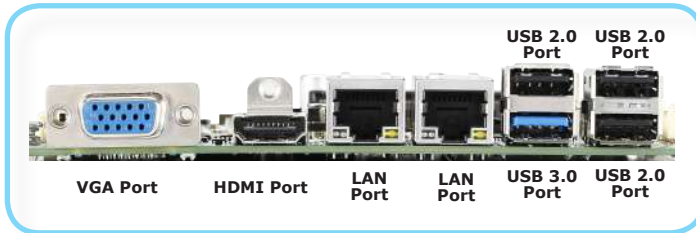

► VGA Port

The DB15-pin female connector is provided for monitor.

► HDMI Port **HDMI™** HIGH-DEFINITION MULTIMEDIA INTERFACE

The High-Definition Multimedia Interface (HDMI) is an all-digital audio-video interface that is capable of transmitting uncompressed streams. HDMI supports all types of TV formats, including standard, enhanced, or high-definition video, plus multi-channel digital audio on a single cable.

► LAN Jack

The standard RJ-45 LAN jack is for connection to the Local Area Network (LAN). You can connect a network cable to it.

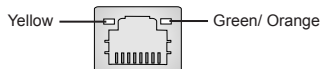

LED	Color	LED State	Condition
Left	Yellow	Off	LAN link is not established.
		On (steady state)	LAN link is established.
		On (blinking)	The computer is communicating with another computer on the LAN.
Right	Green	Off	10 Mbit/sec data rate is selected.
		On	100 Mbit/sec data rate is selected.
	Orange	On	1000 Mbit/sec data rate is selected.

➤ **USB 2.0 Port**

The USB (Universal Serial Bus) port is for attaching USB devices such as keyboard, mouse, or other USB-compatible devices.

➤ **USB 3.0 Port**

The USB 3.0 port is backward-compatible with USB 2.0 devices and supports data transfer rate up to 5 Gbit/s (SuperSpeed).

Connector

Fan Power Connector: SYSFAN1

The fan power connectors support system cooling fan with +12V. When connecting the wire to the connectors, always note that the red wire is the positive and should be connected to the +12V; the black wire is Ground and should be connected to GND. If the motherboard has a System Hardware Monitor chipset onboard, you must use a specially designed fan with speed sensor to take advantage of the system fan control.



GPIO Pin Header: JGPIO1

This connector is provided for the General-Purpose Input/Output (GPIO) peripheral module.

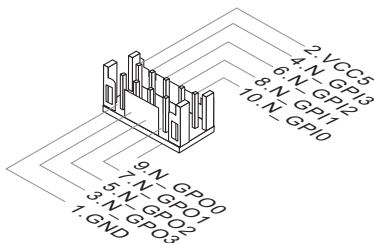

Serial ATA Connector: SATA1

This connector is a high-speed Serial ATA interface port. Each connector can connect to one Serial ATA device.

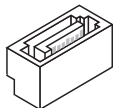

Important

Please do not fold the SATA cable into a 90-degree angle. Otherwise, data loss may occur during transmission.

Front Panel Connector: JFP1

This front panel connector is provided for electrical connection to the front panel switches & LEDs and is compliant with Intel Front Panel I/O Connectivity Design Guide.

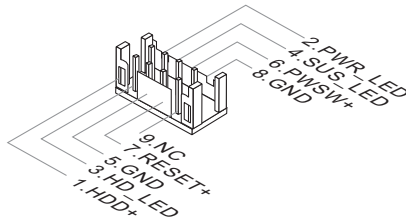

LPC Debug Port Connector: JDP1

This connector is LPC debug port.

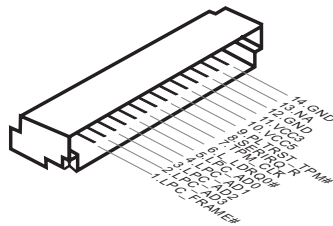

USB 2.0 Connector: JUSB1, JUSB2

This connector, compliant with Intel I/O Connectivity Design Guide, is ideal for connecting high-speed USB interface peripherals such as USB HDD, digital cameras, MP3 players, printers, modems and the like.

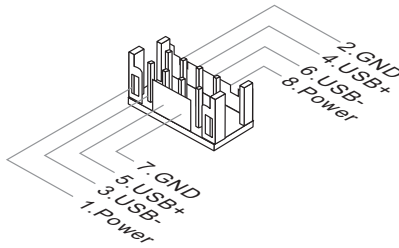

Important

Note that the pins of VCC and GND must be connected correctly to avoid possible damage.

Serial Port Connector: COM1 ~ COM6

This connector is a 16550A high speed communications port that sends/receives 16 bytes FIFOs. You can attach a serial device to it. COM1 supports RS-232/422/ 485. COM2~6 supports RS232.

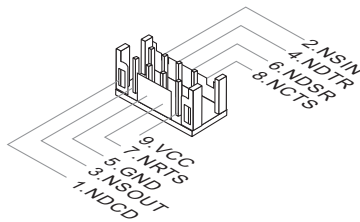

RS-232

PIN	SIGNAL	DESCRIPTION
1	DCD	Data Carrier Detect
2	RXD	Receive Data
3	TXD	Transmit Data
4	DTR	Data Terminal Ready
5	GND	Signal Ground
6	DSR	Data Set Ready
7	RTS	Request To Send
8	CTS	Clear To Send
9	VCC_COM1	Voltage select setting by JCOMP1

RS-422

PIN	SIGNAL	DESCRIPTION
1	422 TXD-	Transmit Data, Negative
2	422 RXD+	Receive Data, Positive
3	422 TXD+	Transmit Data, Positive
4	422 RXD-	Receive Data, Negative
5	GND	Signal Ground
6	NC	No Connection
7	NC	No Connection
8	NC	No Connection
9	NC	No Connection

RS-485

PIN	SIGNAL	DESCRIPTION
1	485 TXD-	Transmit Data, Negative
2	NC	No Connection
3	485 TXD+	Transmit Data, Positive
4	NC	No Connection
5	GND	Signal Ground
6	NC	No Connection
7	NC	No Connection
8	NC	No Connection
9	NC	No Connection

LVDS Inverter Connector: JINVDD1

The connector is provided for LCD backlight options.

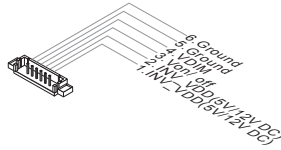

LVDS Connector: JLVDS1

The LVDS (Low Voltage Differential Signal) connector provides a digital interface typically used with flat panels. After connecting an LVDS interface flat panel to the JLVDS1, be sure to check the panel datasheet and set the LVDS jumper to proper power voltage.

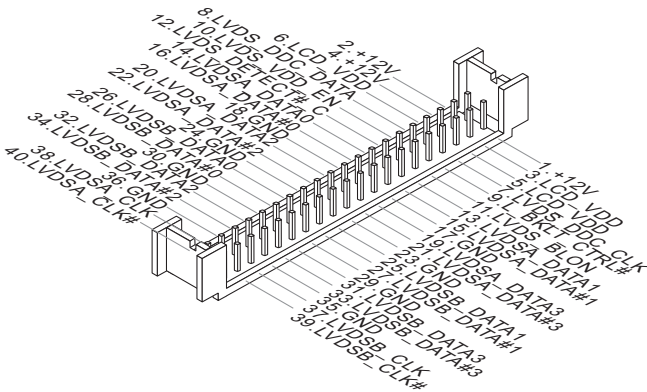

Important

Pin 12 is a detect pin. When using a customized LVDS cable, pin 12 should be a signal ground with a low impedance. Otherwise, LVDS will not function.

Audio Amplifier Pinheader: JAMP1

The JAMP1 is used to connect audio amplifiers to enhance audio performance.

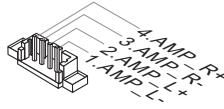

Front Audio Connector: JAUD1

This connector allows you to connect the front panel audio and is compliant with Intel Front Panel I/O Connectivity Design Guide.

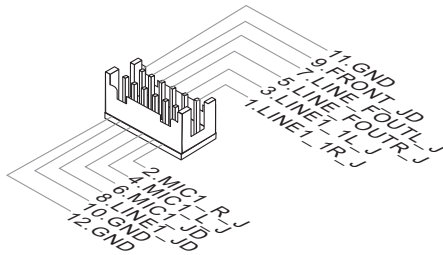

PS/2 Keyboard/Mouse Connector: JKBMS1

This connector is provided to connect a keyboard and a mouse.

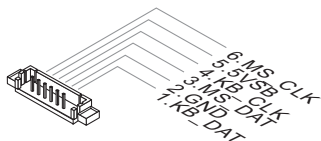

SMBus Connector: JSMB1

This connector is provided for users to connect System Management Bus (SMBus) interface.

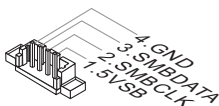

Jumper

Important

Avoid adjusting jumpers when the system is on; it will damage the motherboard.

Clear CMOS Jumper: JCMOS1

There is a CMOS RAM onboard that has a power supply from an external battery to keep the data of system configuration. With the CMOS RAM, the system can automatically boot OS every time it is turned on. If you want to clear the system configuration, set the jumper to clear data.



Normal



Clear CMOS

Important

You can clear CMOS by shorting 2-3 pin while the system is off. Then return to 1-2 pin position. Avoid clearing the CMOS while the system is on; it will damage the motherboard.

AT/ATX Select Jumper: JATX1

This jumper allows users to select between AT and ATX power.



ATX



AT

Serial Port Power Jumper: JCOMP1~3

This jumper specifies the operation voltage of the COM serial port.

JCOMP1~2

JCOMP1 for COM1~2

JCOMP2 for COM3~4

JCOMP3 for COM5~6



+5V



+12V

JCOMP3



+5V



+12V

LAN Configure Jumper: JLAN1~2

Use this jumper to specify the operation for LAN.



On: Enable security and the INVM lock.

JLAN1
(for LAN1)
JLAN2
(for LAN2)



Off: Disable security and the INVM lock.
(non-secure mode)

LVDS Power Jumper: JVDD1

Use this jumper to specify the operation voltage of the LVDS interface flat panel.



LVDS Inverter Power Jumper: JINV1

Use this jumper to specify the operation voltage of the interver interface flat panel.



TXE F/W Jumper: JME1

This jumper is used to enable/disable the Intel TXE F/W.



Slot

Mini-PCle (Peripheral Component Interconnect Express) Slot

The Mini-PCle slot is provided for 3G module, wireless LAN card, TV tuner card, Robson NAND Flash card and mSATA devices.

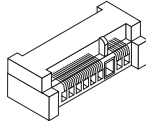

Important

- *MINI_PCIE2 does not support mSATA function.*
- *When adding or removing expansion cards, make sure that you unplug the power supply first. Meanwhile, read the documentation for the expansion card to configure any necessary hardware or software settings for the expansion card, such as jumpers, switches or BIOS configuration.*

3 BIOS Setup

This chapter provides information on the BIOS Setup program and allows users to configure the system for optimal use.

Users may need to run the Setup program when:

- An error message appears on the screen at system startup and requests users to run SETUP.
- Users want to change the default settings for customized features.

Important

- *Please note that BIOS update assumes technician-level experience.*
- *As the system BIOS is under continuous update for better system performance, the illustrations in this chapter should be held for reference only.*

Entering Setup

Power on the computer and the system will start POST (Power On Self Test) process. When the message below appears on the screen, press or <F2> key to enter Setup.

Press or <F2> to enter SETUP

If the message disappears before you respond and you still wish to enter Setup, restart the system by turning it OFF and On or pressing the RESET button. You may also restart the system by simultaneously pressing <Ctrl>, <Alt>, and <Delete> keys.

Important

The items under each BIOS category described in this chapter are under continuous update for better system performance. Therefore, the description may be slightly different from the latest BIOS and should be held for reference only.

Control Keys

← →	Select Screen
↑ ↓	Select Item
Enter	Select
+ -	Change Option
F1	General Help
F7	Previous Values
F9	Optimized Defaults
F10	Save & Exit
Esc	Exit

Getting Help

After entering the Setup menu, the first menu you will see is the Main Menu.

Main Menu

The main menu lists the setup functions you can make changes to. You can use the arrow keys (↑ ↓) to select the item. The on-line description of the highlighted setup function is displayed at the bottom of the screen.

Sub-Menu

If you find a right pointer symbol appears to the left of certain fields that means a sub-menu can be launched from this field. A sub-menu contains additional options for a field parameter. You can use arrow keys (↑ ↓) to highlight the field and press <Enter> to call up the sub-menu. Then you can use the control keys to enter values and move from field to field within a sub-menu. If you want to return to the main menu, just press the <Esc >.

General Help <F1>

The BIOS setup program provides a General Help screen. You can call up this screen from any menu by simply pressing <F1>. The Help screen lists the appropriate keys to use and the possible selections for the highlighted item. Press <Esc> to exit the Help screen.

The Menu Bar

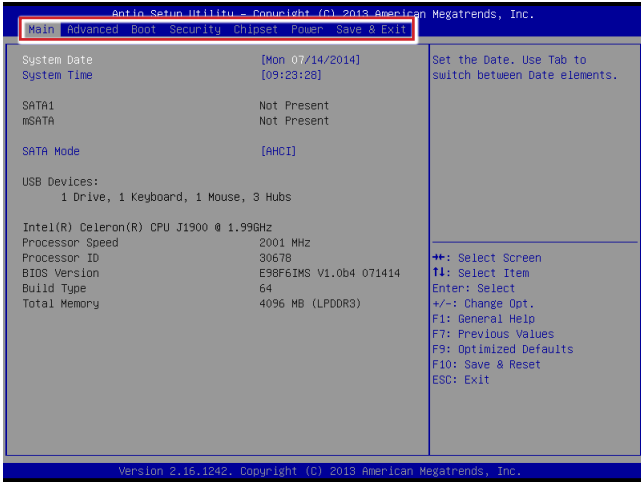

► Main

Use this menu for basic system configurations, such as time, date, etc.

► Advanced

Use this menu to set up the items of special enhanced features.

► Boot

Use this menu to specify the priority of boot devices.

► Security

Use this menu to set supervisor and user passwords.

► Chipset

This menu controls the advanced features of the onboard chipsets.

► Power

Use this menu to specify your settings for power management.

► Save & Exit

This menu allows you to load the BIOS default values or factory default settings into the BIOS and exit the BIOS setup utility with or without changes.

Main

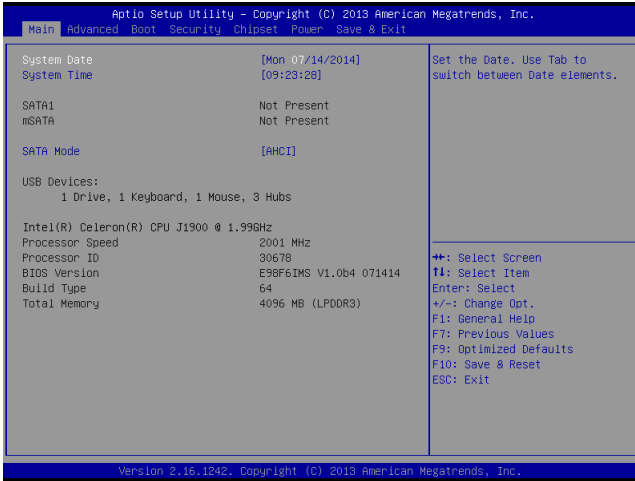

► System Date

This setting allows you to set the system date. The date format is <Day>, <Month> <Date> <Year>.

► System Time

This setting allows you to set the system time. The time format is <Hour> <Minute> <Second>.

► SATA Mode

This setting specifies the SATA controller mode.

Advanced

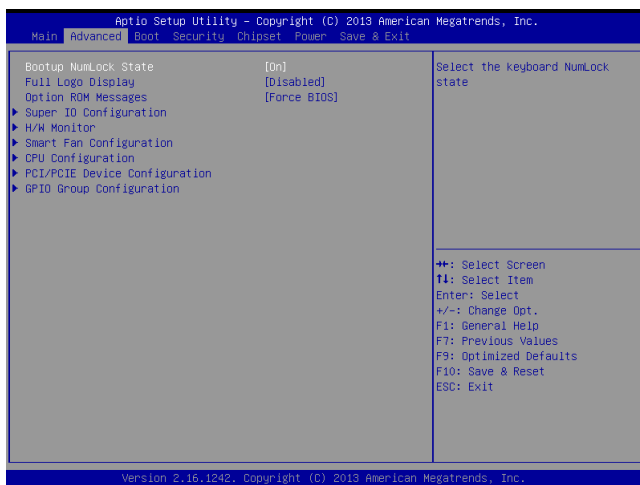

► Bootup NumLock State

This setting is to set the Num Lock status when the system is powered on. Setting to [On] will turn on the Num Lock key when the system is powered on. Setting to [Off] will allow users to use the arrow keys on the numeric keypad.

► Full Logo Display

This BIOS feature determines if the BIOS should hide the normal POST messages with the motherboard or system manufacturer's full-screen logo.

When it is enabled, the BIOS will display the full-screen logo during the boot-up sequence, hiding normal POST messages.

When it is disabled, the BIOS will display the normal POST messages, instead of the full-screen logo.

Please note that enabling this BIOS feature often adds 2-3 seconds of delay to the booting sequence. This delay ensures that the logo is displayed for a sufficient amount of time. Therefore, it is recommended that you disable this BIOS feature for a faster boot-up time.

► Option ROM Messages

This item is used to determine the display mode when an optional ROM is initialized during POST. When set to [Force BIOS], the display mode used by AMI BIOS is used. Select [Keep Current] if you want to use the display mode of optional ROM.

► Super IO Configuration

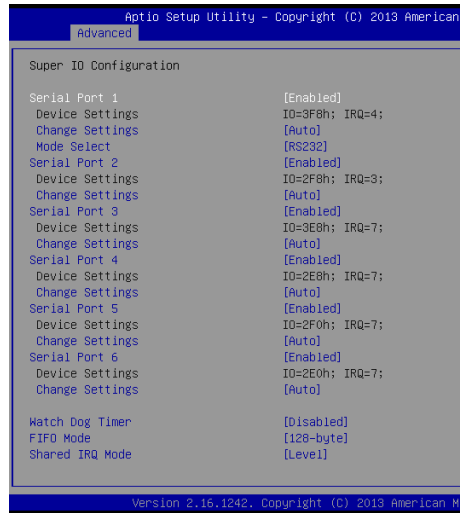

► Serial Port 1/ 2/ 3/ 4/ 5/ 6

This setting enables/disables the specified serial port.

► Change Settings

This setting is used to change the address & IRQ settings of the specified serial port.

► Watch Dog Timer

You can enable the system watch-dog timer, a hardware timer that generates a reset when the software that it monitors does not respond as expected each time the watch dog polls it.

► FIFO Mode

This setting controls the FIFO data transfer mode.

► Shared IRQ Mode

This setting provides the system with the ability to share interrupts among its serial ports.

► **H/W Monitor**

These items display the current status of all monitored hardware devices/ components such as voltages, temperatures and all fans' speeds.

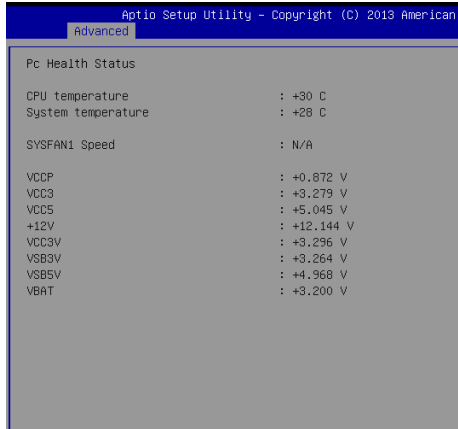

► **Smart Fan Configuration**

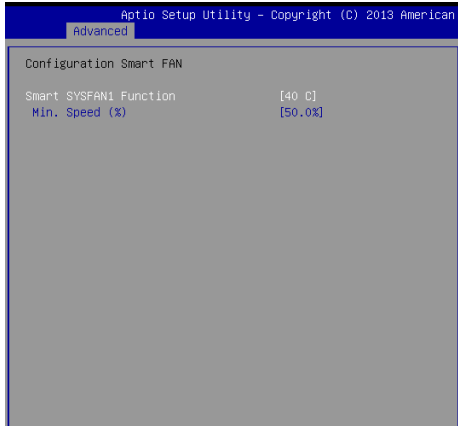

► **Smart FAN1 Function**

These settings enable/disable the Smart Fan function. Smart Fan is an excellent feature which will adjust the CPU/system fan speed automatically depending on the current CPU/system temperature, avoiding the overheating to damage your system.

► Min. Speed (%)

This setting selects the minimum percentage of 12V that the fan needs to start spinning.

► CPU Configuration



► Active Processor Cores

This item allows you to select the number of active processor cores.

► Execute Disable Bit

Intel's Execute Disable Bit functionality can prevent certain classes of malicious "buffer overflow" attacks when combined with a supporting operating system. This functionality allows the processor to classify areas in memory by where application code can execute and where it cannot. When a malicious worm attempts to insert code in the buffer, the processor disables code execution, preventing damage or worm propagation.

► Intel Virtualization Technology

Virtualization enhanced by Intel Virtualization Technology will allow a platform to run multiple operating systems and applications in independent partitions. With virtualization, one computer system can function as multiple "Virtual" systems.

► EIST

EIST (Enhanced Intel SpeedStep Technology) allows the system to dynamically adjust processor voltage and core frequency, which can result in decreased average power consumption and decreased average heat production.

When disabled, the processor will return the actual maximum CPUID input value of the processor when queried.

► PCI/PCIE Device Configuration

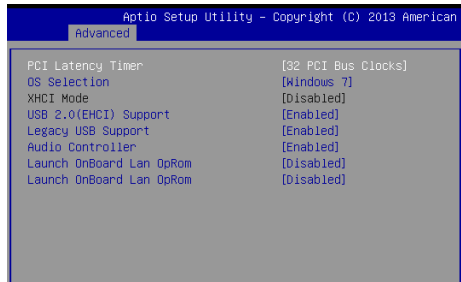

► PCI Latency Timer

This item controls how long each PCI device can hold the bus before another takes over. When set to higher values, every PCI device can conduct transactions for a longer time and thus improve the effective PCI bandwidth. For better PCI performance, you should set the item to higher values.

► OS Selection

Allows you to select the OS version.

[Windows 8] For Windows 8.X

[Windows 7] For Windows 7

► XHCI Mode

This setting disables/enables the USB XHCI controller. The eXtensible Host Controller Interface (XHCI) is a computer interface specification that defines a register-level description of a Host Controller for Universal Serial bus (USB), which is capable of interfacing to USB 1.0, 2.0, and 3.0 compatible devices. The specification is also referred to as the USB 3.0 Host Controller specification.

► USB 2.0 (EHCI) Support

This setting disables/enables the USB EHCI controller. The Enhanced Host Controller Interface (EHCI) specification describes the register-level interface for a Host Controller for the Universal Serial Bus (USB) Revision 2.0.

► Legacy USB Support

Set to [Enabled] if you need to use any USB 1.1/2.0 device in the operating system that does not support or have any USB 1.1/2.0 driver installed, such as DOS and SCO Unix.

► **Audio Controller**

This setting enables/disables the onboard audio controller.

► **Launch OnBoard LAN OpROM**

These settings enable/disable the initialization of the onboard/onchip LAN Boot ROM during bootup. Selecting [Disabled] will speed up the boot process.

► **GPIO Group Configuration**

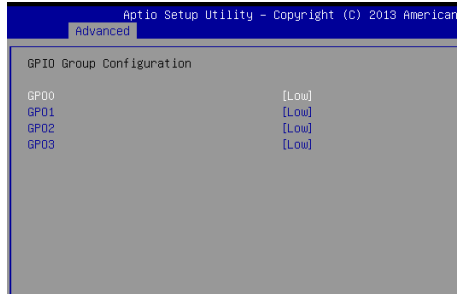

► **GPO0 ~ GPO3**

These settings control the operation mode of the specified GPIO.

Boot

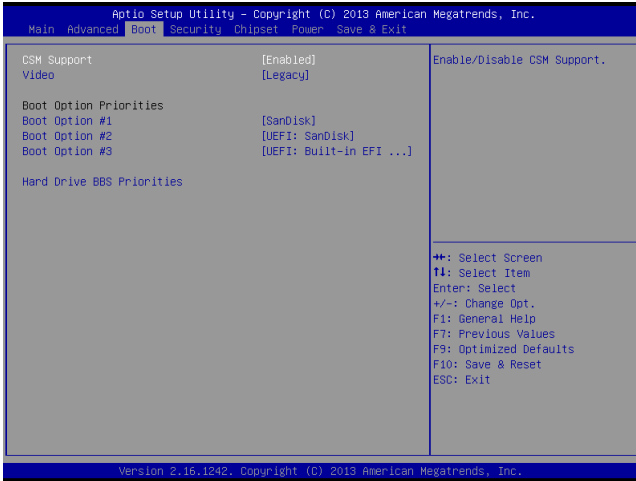

► CSM Support

This setting enables/disables the support for Compatibility Support Module, a part of the Intel Platform Innovation Framework for EFI providing the capability to support legacy BIOS interfaces.

Important

*If the Operating System is going to boot in UEFI mode, disable **CSM Support** to speed up the boot process.*

► Video

Allows you to select the OS mode.

[EFI Mode OS] For UEFI mode.

[Legacy Mode OS] For Legacy mode.

► Boot Option Priorities

This setting allows users to set the sequence of boot devices where BIOS attempts to load the disk operating system.

► Hard Drive BBS Priorities

This setting allows users to set the priority of the specified devices. First press <Enter> to enter the sub-menu. Then you may use the arrow keys (↑↓) to select the desired device, then press <+>, <-> or <PageUp>, <PageDown> key to move it up/down in the priority list.

Security

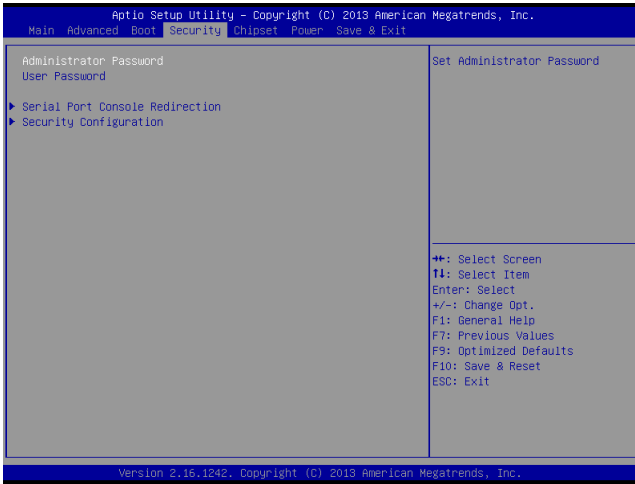

► Administrator Password

Administrator Password controls access to the BIOS Setup utility.

► User Password

User Password controls access to the system at boot and to the BIOS Setup utility.

► **Serial Port Console Redirection**

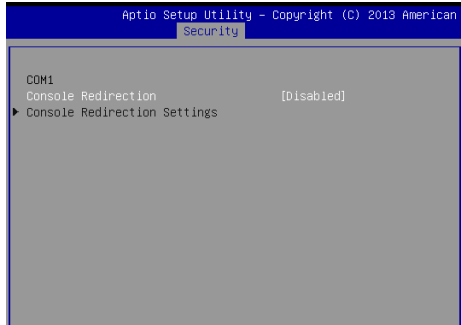

► **Console Redirection**

Console Redirection operates in host systems that do not have a monitor and keyboard attached. This setting enables/disables the operation of console redirection. When set to [Enabled], BIOS redirects and sends all contents that should be displayed on the screen to the serial COM port for display on the terminal screen. Besides, all data received from the serial port is interpreted as keystrokes from a local keyboard.

► **Console Redirection Settings**

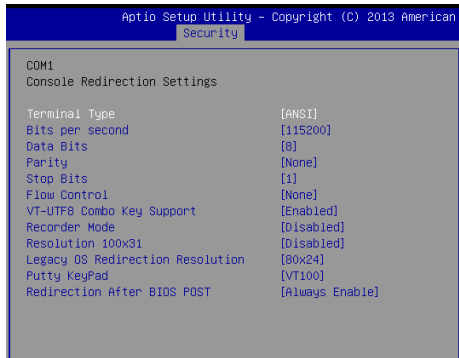

► Terminal Type

To operate the system's console redirection, you need a terminal supporting ANSI terminal protocol and a RS-232 null modem cable connected between the host system and terminal(s). This setting specifies the type of terminal device for console redirection.

► Bits per second, Data Bits, Parity, Stop Bits

This setting specifies the transfer rate (bits per second, data bits, parity, stop bits) of Console Redirection.

► Flow Control

Flow control is the process of managing the rate of data transmission between two nodes. It's the process of adjusting the flow of data from one device to another to ensure that the receiving device can handle all of the incoming data. This is particularly important where the sending device is capable of sending data much faster than the receiving device can receive it.

► VT-UTF8 Combo Key Support

This setting enables/disables the VT-UTF8 combination key support for ANSI/VT100 terminals.

► Recorder Mode, Resolution 100x31

These settings enable/disable the recorder mode and the resolution 100x31.

► Legacy OS Redirection Resolution

This setting specifies the redirection resolution of legacy OS.

► Putty Keypad

PuTTY is a terminal emulator for Windows. This setting controls the numeric keypad for use in PuTTY.

► Redirection After BIOS POST

This setting determines whether or not to keep terminals?console redirection running after the BIOS POST has booted.

► **Security Configuration**

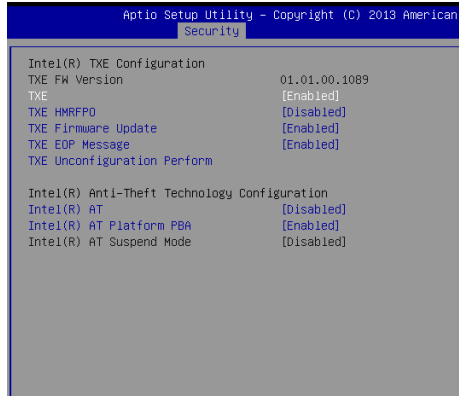

► **Intel(R) TXE Configuration**

Intel Trusted Execution Technology provides highly scalable platform security in physical and virtual infrastructures.

► **Intel(R) Anti-Theft Technology Configuration**

Intel Anti-Theft Technology is hardware-based technology that can lock a lost or stolen system so that personal confidential information is protected and inaccessible by unauthorized users.

Chipset

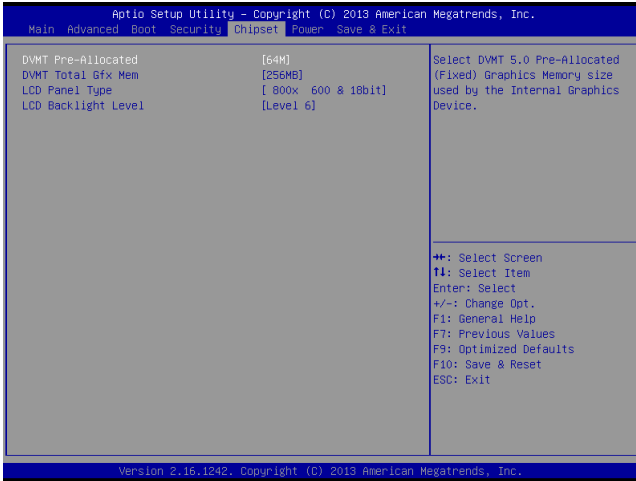

► DVMT Pre-Allocated

This setting defines the DVMT pre-allocated memory. Pre-allocated memory is the small amount of system memory made available at boot time by the system BIOS for video. Pre-allocated memory is also known as locked memory. This is because it is "locked" for video use only and as such, is invisible and unable to be used by the operating system.

► DVMT Total Gfx Mem

This setting specifies the memory size for DVMT.

► LCD Panel Type

This setting allows you to set the resolution of the LCD display.

► LCD Backlight Level

This setting allows you to set the LCD backlight level.

Power

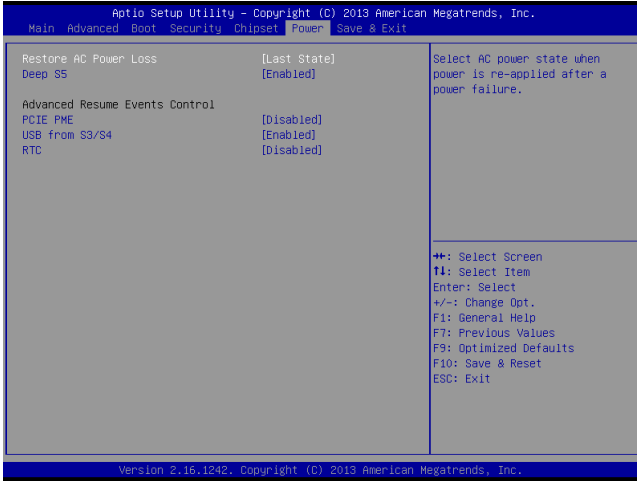

► Restore AC Power Loss

This setting specifies whether your system will reboot after a power failure or interrupt occurs. Available settings are:

[Power Off]	Leaves the computer in the power off state.
[Power On]	Leaves the computer in the power on state.
[Last State]	Restores the system to the previous status before power failure or interrupt occurred.

► Deep S5

The setting enables/disables the Deep S5 power saving mode. S5 is almost the same as G3 Mechanical Off, except that the PSU still supplies power, at a minimum, to the power button to allow return to S0. A full reboot is required. No previous content is retained. Other components may remain powered so the computer can “wake” on input from the keyboard, clock, modem, LAN, or USB device.

**** Advanced Resume Events Control ******▶ PCIE PME**

This field specifies whether the system will be awakened from power saving modes when activity or input signal of onboard PCIE PME is detected.

▶ USB from S3/S4

The item allows the activity of the USB device to wake up the system from S3/S4 sleep state.

▶ RTC

When [Enabled], you can set the date and time at which the RTC (real-time clock) alarm awakens the system from suspend mode.

Save & Exit

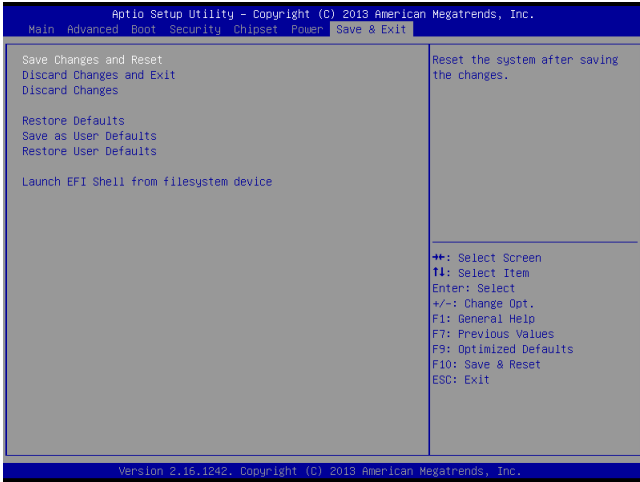

► Save Changes and Reset

Save changes to CMOS and reset the system.

► Discard Changes and Exit

Abandon all changes and exit the Setup Utility.

► Discard Changes

Abandon all changes.

► Restore Defaults

Use this menu to load the default values set by the motherboard manufacturer specifically for optimal performance of the motherboard.

► Save as User Defaults

Save changes as the user's default profile.

► Restore User Defaults

Restore the user's default profile.

► Launch EFI Shell from filesystem device

This setting helps to launch the EFI Shell application from one of the available file system devices.

Appendix

WDT & GPIO



This appendix provides the sample codes of WDT (Watch Dog Timer) and GPIO (General Purpose Input/ Output).

WDT Sample Code

```

SIO_INDEX_Port    equ 04Eh
SIO_DATA_Port     equ 04Fh
SIO_UnLock_Value  equ 087h
SIO_Lock_Value    equ 0AAh
WatchDog_LDN      equ 007h
WDT_UNIT          equ 60h    ;60h=second, 68h=minute, 40h=Disabled watchdog timer
WDT_Timer         equ 30     ;ex. 30 seconds

```

Sample code:

```

;Enable config mode
mov    dx, SIO_INDEX_Port
mov    al, SIO_UnLock_Value
out    dx, al
jmp    short $+2          ;Io_delay
jmp    short $+2          ;Io_delay
out    dx, al

;Change to WDT
mov    dx, SIO_INDEX_Port
mov    al, 07h
out    dx, al
mov    dx, SIO_DATA_Port
mov    al, WatchDog_LDN
out    dx, al

;Active WDT
mov    dx, SIO_INDEX_Port
mov    al, 30h
out    dx, al
mov    dx, SIO_DATA_Port
in     al, dx
or     al, 01h
out    dx, al

;set timer
mov    dx, SIO_INDEX_Port
mov    al, 0F6h
out    dx, al
mov    dx, SIO_DATA_Port
mov    al, WDT_Timer
out    dx, al

;set UINIT
mov    dx, SIO_INDEX_Port
mov    al, 0F5h
out    dx, al
mov    dx, SIO_DATA_Port
mov    al, WDT_UNIT
out    dx, al

;enable reset
mov    dx, SIO_INDEX_Port
mov    al, 0FAh
out    dx, al
mov    dx, SIO_DATA_Port
in     al, dx
or     al, 01h
out    dx, al

;close config mode
mov    dx, SIO_INDEX_Port
mov    al, SIO_Lock_Value
out    dx, al

```

GPIO Sample Code

- GPI 0 ~ GPI 3

	GPI 0	GPI 1	GPI 2	GPI 3				
IO Address								
SIO_GPIO_Register	82h	82h	82h	82h				
Bit	0	1	2	3				
Sample code	#1							

- GPO 0 ~ GPO 3

	GPO 0	GPO 1	GPO 2	GPO 3				
IO Address								
SIO_GPIO_Register	81h	81h	81h	81h				
Bit	4	5	6	7				
Sample code	#2							

```

SIO_INDEX_Port    equ    04Eh
SIO_DATA_Port     equ    04Fh
SIO_UnLock_Value  equ    087h
SIO_Lock_Value    equ    0AAh
SIO_LDN_GPIO      equ    06h
GPI_REG           equ    082h
GPO_REG           equ    081h
GPI_ADD           equ    000h
GPO_ADD           equ    000h
GPO_0             equ    00010000b

```

Sample Code:

#1 : Get GPI 0 status

; Enable config mode

```

mov  dx, SIO_INDEX_Port
mov  al, SIO_UnLock_Value
out  dx, al
jmp  short $+2          ;Io_delay
jmp  short $+2          ;Io_delay
out  dx, al

```

; Switch GPIO Configuration for SIO LDN 0x06

```

mov  dx, SIO_INDEX_Port
mov  al, 07h
out  dx, al
mov  dx, SIO_DATA_Port
mov  al, SIO_LDN_GPIO
out  dx, al

```

; Get GPI 0 Pin Status Register

```

mov dx, SIO_INDEX_Port
mov al, GPI_REG
out dx, al
mov dx, SIO_DATA_Port
in al, dx
;al bit0 = GPI 0 status

```

; Exit SIO

```

mov dx, SIO_INDEX_Port
mov al, SIO_Lock_Value
out dx, al

```

#2 : Set GPO 0 status to high***; Enable config mode***

```

mov dx, SIO_INDEX_Port
mov al, SIO_UnLock_Value
out dx, al
jmp short $+2 ;Io_delay
jmp short $+2 ;Io_delay
out dx, al

```

; Switch GPIO Configuration for SIO LDN 0x06

```

mov dx, SIO_INDEX_Port
mov al, 07h
out dx, al
mov dx, SIO_DATA_Port
mov al, SIO_LDN_GPIO
out dx, al

```

; Set GPO 0 Pin to High

```

mov dx, SIO_INDEX_Port
mov al, GPO_REG
out dx, al
mov dx, SIO_DATA_Port
in al, dx
or al, GPO_0
out dx, al
;al bit4 = GPO 0 status

```

; Exit SIO

```

mov dx, SIO_INDEX_Port
mov al, SIO_Lock_Value
out dx, al

```