

Rigid-770

Extreme Rugged Intel® Core™ i3-3120ME Fanless Embedded Controller

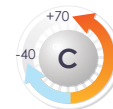

Features

- **Wide Operating Temperature (-40 ~70°C)**
- **Fanless Design**
- Wide-Range DC Power Input (9 ~36V)
- iAMT supported
- Various Video Interfaces (DVI-I + DVI-D) supported
- Optional Wi-Fi or HSUPA Wireless Connectivity supported
- Rugged Design for Shock/Vibration Protection
- Memory support up to 16GB (DDR3)
- RAID 0, 1 support
- Intel® SSD compatible

System

CPU	Intel® Core™ i3-3120ME 2.4GHz
Memory	2 x 204-pin DDR3 SO-DIMM sockets, supporting 1333/1600MHz SDRAM up to 16GB 4GB WT DDR3 memory module installed
Chipset	Intel® QM77
Graphics	Integrated Intel® HD 4000
ATA	2 x Serial ATA ports with 600MB/s HDD transfer rate 2 x eSATA
LAN Chipset	2 x Intel® WG82583V GbE controllers 1 x Intel® WG82579LM GbE PHY w/ iAMT
Watchdog Timer	1~255 levels reset

I/O

Serial Port	1 x DB-44 female connector COM1 & COM2 are RS-232 COM3 & COM4 are RS-232/422/485 configurable, w/ isolated protection
USB Port	6 x USB 2.0 ports, 4 x USB 3.0 / 2.0 ports
LAN	3 x RJ-45 ports for GbE
Video Port	1 x DVI-I female connector for Digital/Analog Video output 1 x DVI-D female connector for Digital Video output
Selectable Port	1 x DB25 connector for 1 x DIO port (8 x IN, 8 x OUT) or 1 x LPT port (either one) Default is DIO, can be changed to LPT
Audio	Mic-in/Line-out
Expansion Bus	1 x Mini-card slot interconnected with SIM card socket for optional Wi-Fi or HSUPA module 1 x SIM socket/1 x CFast socket (outside accessible)

Environmental

Operating Temp.	-40 ~ 70°C (-40 ~ 158°F), ambient w/ air flow
Storage Temp.	-40 ~ 85°C (-40 ~ 185°F)
Operating Humidity	10 ~ 95% @ 70°C (non-condensing)
Vibration	3 Grms/5~500Hz/random operation w/ SSD
Shock	Operating 40G (11ms), Non-operating 60G with SSD

Qualification

Certification	CE, FCC Class A
Power Requirement	
Power Input	DC 9~36V input w/ 4-pin terminal block
Power Consumption	Max. 50W

Storage

Type	2 x 2.5" drive bays 1 x CFast socket
------	---

Mechanical

Construction	Aluminum alloy
Mounting	Wall-mount
Weight	6.4 kg (14.1 lb)
Dimensions (W x H x D)	225 x 90 x 267 mm

OS Support

XP Pro / W7 Pro / WS7E / WE8 STD

Ordering Information

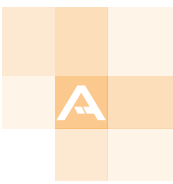

Rigid-770	Fanless system w/o expansion
-----------	------------------------------



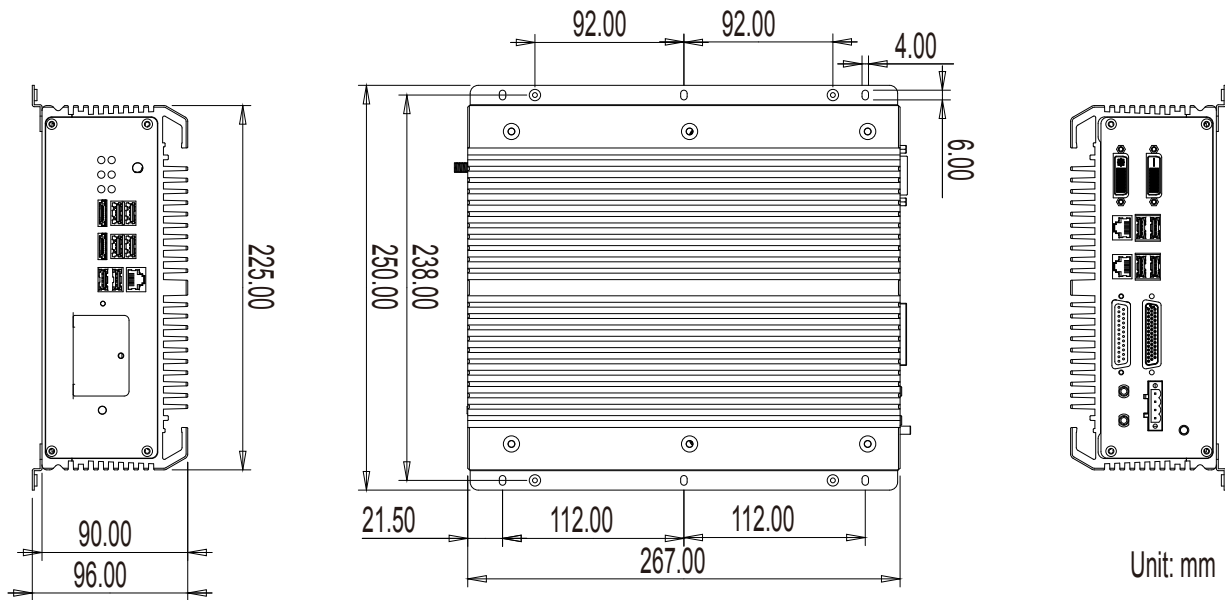



Dimensions



Standard Accessories

PAC-B120W-FSP	19V/6.32A 120W AC/DC adapter kit	
CBL-7100-COM	4 x COM ports converter cable	
WMK-7000	Wall-mount kit for FPC-7XXX Series	

Optional Configuration (CTOS* Kit)

80GB SSD	Intel® 2.5" 80GB SATAIII SSD kit	
MK-3I-4G-2	Industrial-grade DDR3 4GB SDRAM DIMM2 kit	
MK-3I-8G-2	Industrial-grade DDR3 8GB SDRAM DIMM2 kit	
WiFi-AT2300	Atheros AR9462 Wi-Fi module w/ 20cm internal wiring	
HSPA-SI1400	HSUPA 3.75G module kit & internal wiring	
ANT-H11	1 x 2dBi HSUPA antenna	
ANT-D11	1 x Wi-Fi Dual-band 2.4G/5G antenna	

*CTOS means Configure-to-Order Service.