Em104-i290K

PC/104 CPU Module

User's Manual

Version 1.0

This page is intentionally left blank.

Revision History

Version	Release Time	Description
1.0	September 2013	Initial release

Revision History	i
Table of Contents	ii
Preface.....	v
Copyright Notice	v
Declaration of Conformity	v
CE.....	v
FCC Class A	vi
RoHS	vi
SVHC / REACH	vi
Replacing Lithium Battery	vii
Technical Support	vii
Warranty.....	viii
Chapter 1 - Introduction.....	1
1.1. The Product	2
1.2. About this Manual	2
1.3. Specifications.....	3
1.4. Inside the Package	4
1.5. Ordering Information	4
1.5.1. Optional Accessories	4
Chapter 2 - Getting Started.....	5
2.1. Board Dimensions.....	6
2.2. Block Diagram.....	7
2.3. Jumpers and Connectors.....	8
2.3.1. Layout.....	8
2.3.2. Jumpers	10
2.3.3. Connectors	13
2.4. Driver Installation Notes.....	26
Chapter 3 - BIOS.....	27
3.1. Main	29
3.2. Advanced	30
3.2.1. CPU Configuration.....	31
3.2.2. IDE Configuration	32
3.2.3. Super IO Configuration	35
3.2.4. Hardware Health Configuration	37
3.2.5. AHCI Configuration	38
3.2.6. USB Configuration	39
3.3. Chipset.....	40
3.3.1. North Bridge Configuration	41
3.3.2. South Bridge Configuration.....	43

3.4. PCI PnP	44
3.5. Boot.....	46
3.6. Security	47
3.7. Exit.....	48
Appendices	49
Appendix A. I/O Port Address Map	50
Appendix B. Memory Address Map.....	52
Appendix C. Interrupt Request Lines (IRQ)	54
Appendix D. DMA Map.....	58
Appendix E: Watchdog Timer (WDT) Setting.....	59

This page is intentionally left blank.

Copyright Notice

All Rights Reserved.

The information in this document is subject to change without prior notice in order to improve the reliability, design and function. It does not represent a commitment on the part of the manufacturer.

Under no circumstances will the manufacturer be liable for any direct, indirect, special, incidental, or consequential damages arising from the use or inability to use the product or documentation, even if advised of the possibility of such damages.

This document contains proprietary information protected by copyright. All rights are reserved. No part of this manual may be reproduced by any mechanical, electronic, or other means in any form without prior written permission of the manufacturer.

Declaration of Conformity

CE

The CE symbol on your product indicates that it is in compliance with the directives of the Union European (EU). A Certificate of Compliance is available by contacting Technical Support.

This product has passed the CE test for environmental specifications when shielded cables are used for external wiring. We recommend the use of shielded cables. This kind of cable is available from ARBOR. Please contact your local supplier for ordering information.

This product has passed the CE test for environmental specifications. Test conditions for passing included the equipment being operated within an industrial enclosure. In order to protect the product from being damaged by ESD (Electrostatic Discharge) and EMI leakage, we strongly recommend the use of CE-compliant industrial enclosure products.

Warning

This is a class A product. In a domestic environment this product may cause radio interference in which case the user may be required to take adequate measures.

FCC Class A

This device complies with Part 15 of the FCC Rules. Operation is subject to the following two conditions:

- (1) This device may not cause harmful interference, and
- (2) This device must accept any interference received, including interference that may cause undesired operation.

NOTE:

This equipment has been tested and found to comply with the limits for a Class A digital device, pursuant to Part 15 of the FCC Rules. These limits are designed to provide reasonable protection against harmful interference when the equipment is operated in a commercial environment. This equipment generates, uses, and can radiate radio frequency energy and, if not installed and used in accordance with the instruction manual, may cause harmful interference to radio communications. Operation of this equipment in a residential area is likely to cause harmful interference in which case the user will be required to correct the interference at his own expense.

RoHS

ARBOR Technology Corp. certifies that all components in its products are in compliance and conform to the European Union's Restriction of Use of Hazardous Substances in Electrical and Electronic Equipment (RoHS) Directive 2002/95/EC.

The above mentioned directive was published on 2/13/2003. The main purpose of the directive is to prohibit the use of lead, mercury, cadmium, hexavalent chromium, polybrominated biphenyls (PBB), and polybrominated diphenyl ethers (PBDE) in electrical and electronic products. Member states of the EU are to enforce by 7/1/2006.

ARBOR Technology Corp. hereby states that the listed products do not contain unintentional additions of lead, mercury, hex chrome, PBB or PBDB that exceed a maximum concentration value of 0.1% by weight or for cadmium exceed 0.01% by weight, per homogenous material. Homogenous material is defined as a substance or mixture of substances with uniform composition (such as solders, resins, plating, etc.). Lead-free solder is used for all terminations (Sn(96-96.5%), Ag(3.0-3.5%) and Cu(0.5%)).

SVHC / REACH

To minimize the environmental impact and take more responsibility to the earth we live, Arbor hereby confirms all products comply with the restriction of SVHC

(Substances of Very High Concern) in (EC) 1907/2006 (REACH --Registration, Evaluation, Authorization, and Restriction of Chemicals) regulated by the European Union.

All substances listed in SVHC < 0.1 % by weight (1000 ppm)

Warning

Single Board Computers and their components contain very delicate Integrated Circuits (IC). To protect the Single Board Computer and its components against damage from static electricity, you should always follow the following precautions when handling it :

1. Disconnect your Single Board Computer from the power source when you want to work on the inside.
2. Hold the board by the edges and try not to touch the IC chips, leads or circuitry.
3. Use a grounded wrist strap when handling computer components.
4. Place components on a grounded antistatic pad or on the bag that comes with the Single Board Computer, whenever components are separated from the system.

Replacing Lithium Battery

Incorrect replacement of the lithium battery may lead to a risk of explosion.

The lithium battery must be replaced with an identical battery or a battery type recommended by the manufacturer.

Do not throw lithium batteries into the trash-can. It must be disposed of in accordance with local regulations concerning special waste.

Technical Support

If you have any technical difficulties, please do not hesitate to call or e-mail our customer service.

<http://www.arbor.com.tw>

E-mail: info@arbor.com.tw

Warranty

This product is warranted to be in good working order for a period of two years from the date of purchase. Should this product fail to be in good working order at any time during this period, we will, at our option, replace or repair it at no additional charge except as set forth in the following terms. This warranty does not apply to products damaged by misuse, modifications, accident or disaster.

Vendor assumes no liability for any damages, lost profits, lost savings or any other incidental or consequential damage resulting from the use, misuse of, or inability to use this product. Vendor will not be liable for any claim made by any other related party. Vendors disclaim all other warranties, either expressed or implied, including but not limited to implied warranties of merchantability and fitness for a

particular purpose, with respect to the hardware, the accompanying product's manual(s) and written materials, and any accompanying hardware. This limited warranty gives you specific legal rights.

Return authorization must be obtained from the vendor before returned

merchandise will be accepted. Authorization can be obtained by calling or faxing the vendor and requesting a Return Merchandise Authorization (RMA) number. Returned goods should always be accompanied by a clear problem description.

Chapter 1

Introduction

1.1. The Product

The Em104-i290K is a PC/104 CPU board loaded with Intel® Atom™ N455 processor, Intel® ICH8M chipset and Intel® Graphics Media Accelerator 3150. It comes with rich IO ports to answer market needs including four serial ports that are RS232/RS485 configurable, two USB ports, PS/2 ports for keyboard and mouse, one serial ATA for HDD or SSD storage, and one VGA port for video output.

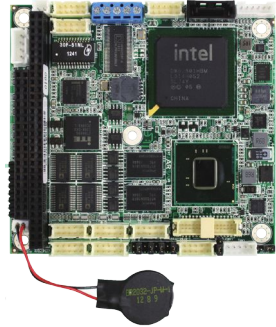

1.2. About this Manual

This manual is intended for experienced users and integrators with hardware knowledge of computers. If you are not sure about the description in this manual, consult your vendor before further handling.

We recommend that you keep one copy of this manual for the quick reference for any necessary maintenance in the future. Thank you for choosing ARBOR products.

1.3. Specifications

System	
CPU	Soldered onboard Intel® Atom™ N455 1.66GHz processor
Memory	Soldered onboard 1GB DDR3 SDRAM
Chipset	Intel® ICH8M
BIOS	AMI PnP Flash BIOS
Watchdog Timer	1 ~ 255 levels reset
I/O	
I/O Chipset	Fintek F81866
Serial Port	4 x RS-232/485 selectable ports (RS-485 with auto flow control)
USB Port	2 x USB 2.0 ports
KB/MS	6-pin wafer connector for keyboard and mouse
Expansion Bus	PC/104 interface
Storage	1 x Serial ATA port with 300MB/s HDD transfer rate
	1 x CompactFlash Type II socket
Ethernet Chipset	2 x Intel® 82583V PCIe GbE controllers
Display	
Graphics Chipset	Integrated Intel® Graphics Media Accelerator 3150
Graphics Interface	Analog RGB supports resolution up to 2048 x 1536
	LCD: Single channel 18-bit LVDS
Mechanical & Environmental	
Power Requirement	+5V (Additional +12V might be required for LCD panel)
Power Consumption	2.4A@+5V (Typical)
Operating Temp.	-20 ~ 70°C (-4 ~ 158°F)
Operating Humidity	10%~95% @ 70°C (non-condensing)
Dimension (L x W)	95.89 x 90.17 mm (3.775" x 3.549")

1.4. Inside the Package

Before starting to install the single board, make sure the following items are shipped:



1 x Em104-i290K-N4



1 x Driver CD



1 x Quick Installation Guide

If any of the above items is damaged or missing, contact your vendor immediately.

1.5. Ordering Information

Em104-i290K-N4	Intel® Atom™ N455 PC/104 CPU module
-----------------------	-------------------------------------

1.5.1. Optional Accessories

CBK-11-290K-00	Cable kit 1 x SATA cable 1 x SATA Power cable 4 x Serial port cables 1 x KB & MS Y-cable 1 x USB cable 1 x VGA cable 2 x LAN cables
-----------------------	--

Chapter 2

Getting Started

2.1. Board Dimensions

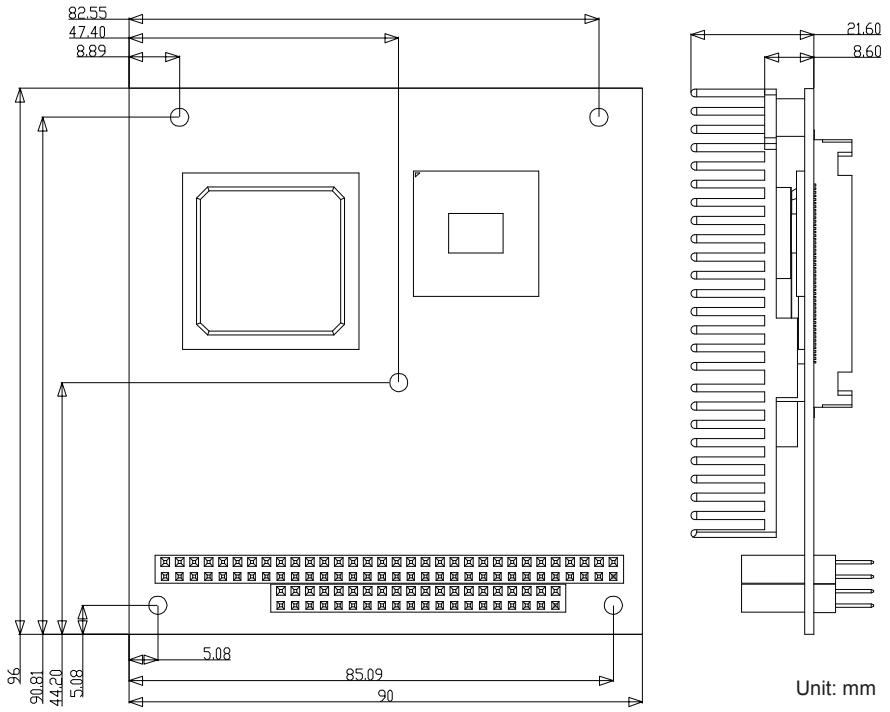

2.2. Block Diagram

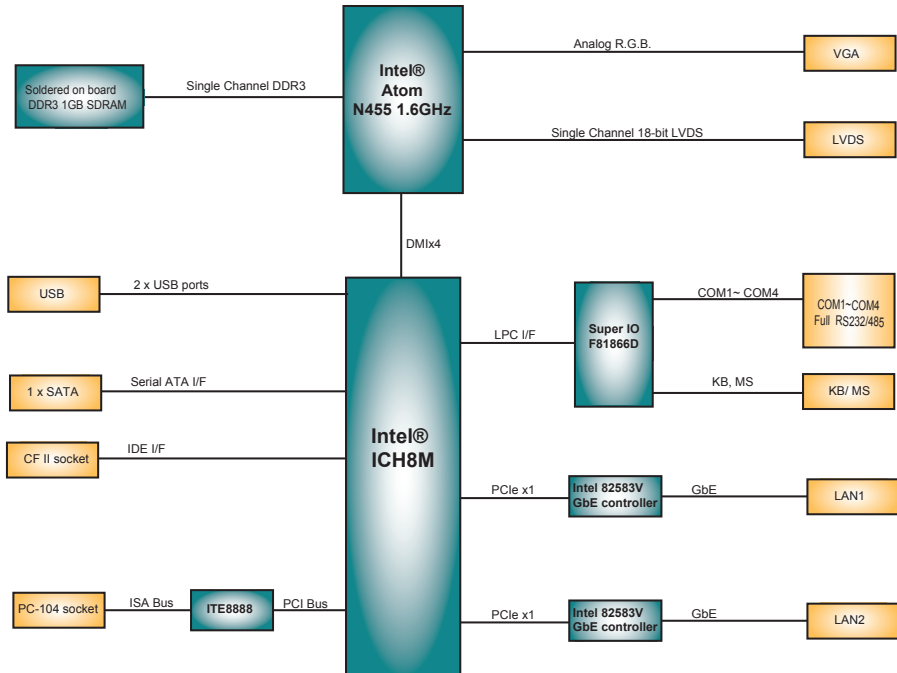

2.3. Jumpers and Connectors

The board comes with some connectors to join some devices and also some jumpers to alter the hardware configuration. The following in this chapter will explicate each of these components one-by-one.

2.3.1. Layout

This section will provide an overview of this board, both the top and bottom sides.

Board Top

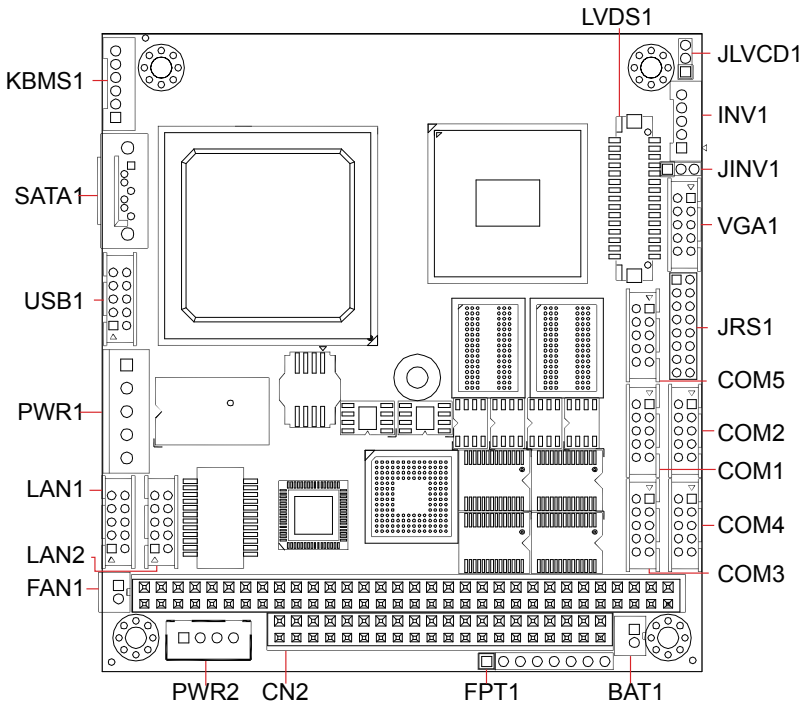

Board Bottom

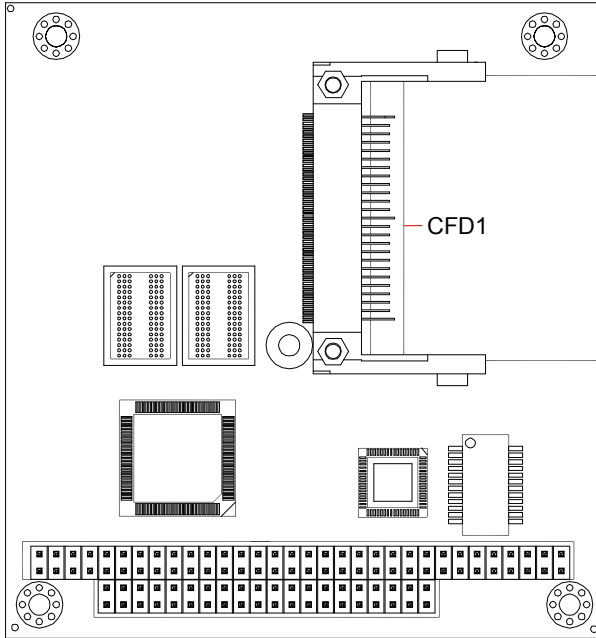

2.3.2. Jumpers

JLVCD1

Function: Sets LCD panel voltage
Jumper Type: 2.00mm pitch, 1x3-pin header
Setting:

Pin	Description
1-2	+5V
2-3	+3.3V (default)

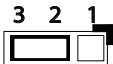
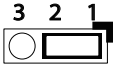

Board Top

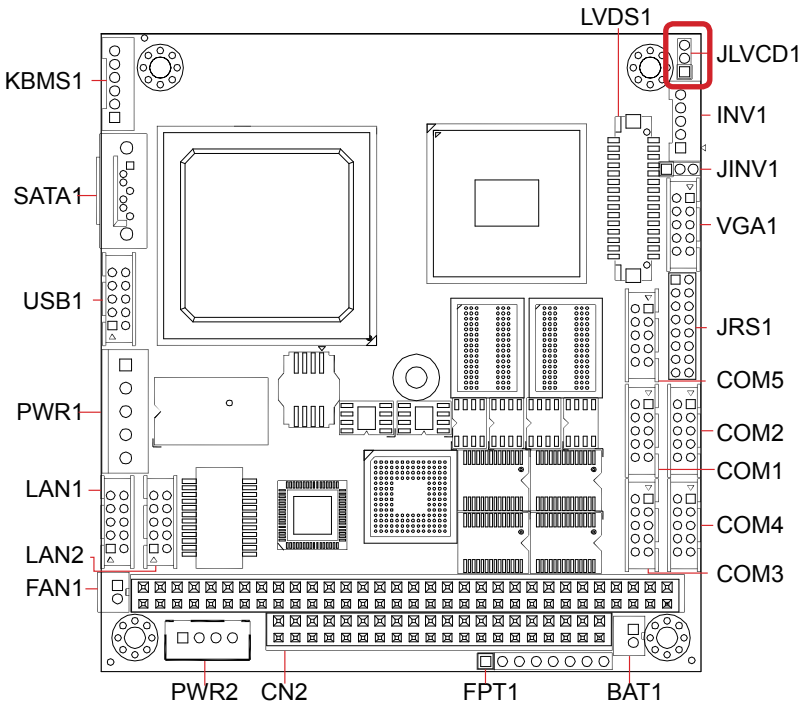

JINV1

Function: Sets LCD inverter voltage. (This jumper sets the voltage of LCD connector INV1, which means this jumper decides the pin 1 of the LCD connector INV1.)

Jumper Type: 2.00mm pitch, 1x3-pin header

Setting:

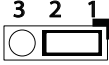
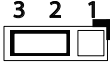
Pin	Description	
1-2	+12V	
2-3	+5V (default)	

Board Top

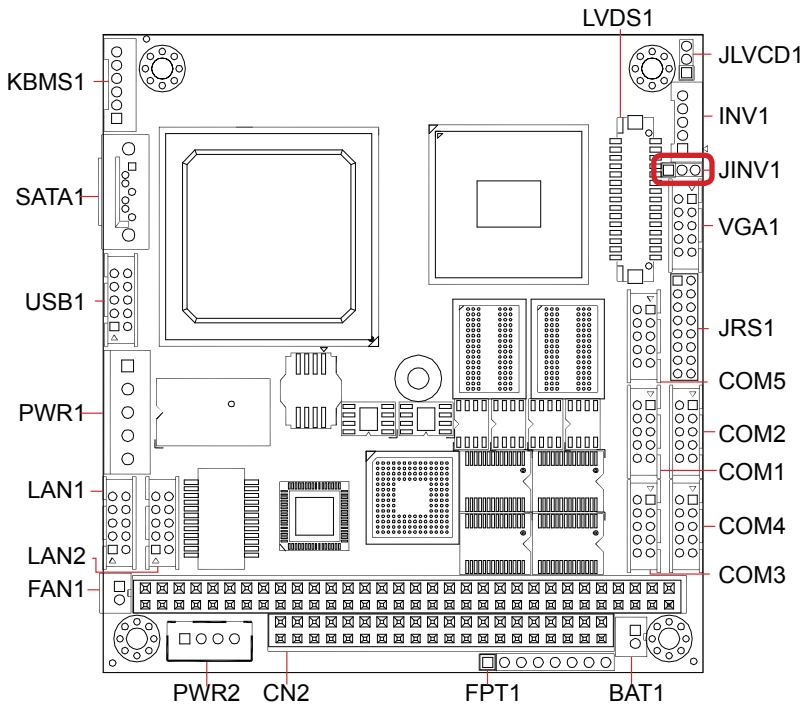

JRS1

Function: Configures COM1 to COM4 between RS-232 and RS-485.

Jumper Type: 2.00mm pitch, 2x8-pin header

Setting:

Pin	Description	1	2
1-2	COM1 RS-232 (default)		
3-4	COM1 RS-485*		
5-6	COM2 RS-232 (default)		
7-8	COM2 RS-485*		
9-10	COM3 RS-232 (default)		
11-12	COM3 RS-485*		
13-14	COM4 RS-232 (default)		
15-16	COM4 RS-485*		

*To set a COM port to RS-485, be sure to make consistent settings in BIOS | **Advanced** menu | **Super IO Configuration** except herewith this jumper to prevent possible conflict. See [3.2.3. Super IO Configuration](#) on page [35](#) for more details.

Board Top

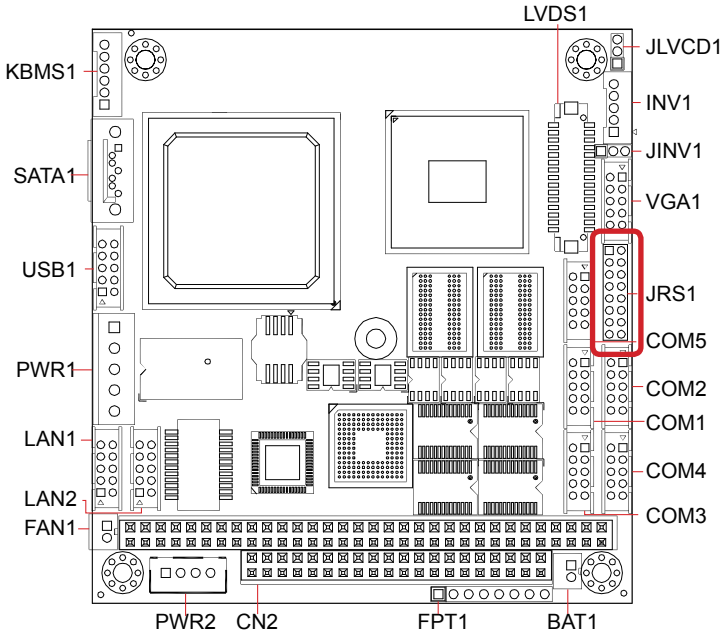

2.3.3. Connectors

INV1

Description: LCD inverter connector

Connector Type: 2.00mm pitch 1x5-pin box wafer connector

Setting:

Pin	Description
1	Vin
2	GND
3	on/off
4	Brightness control
5	GND

1

5



Board Top

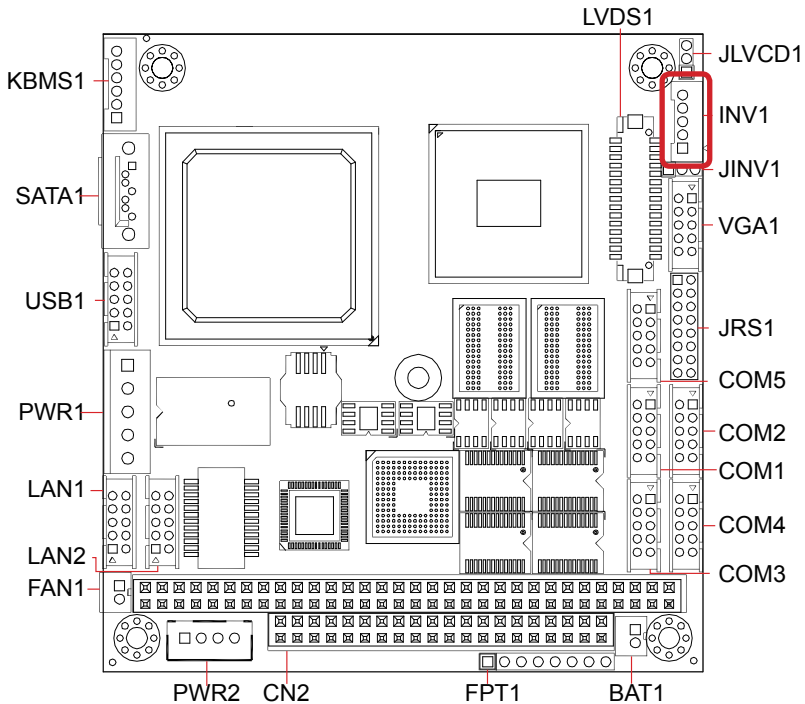

VGA1

Description: Analog RGB output connector

Connector Type: 2.00mm pitch 2x5-pin headers

Setting:

Pin	Description	Pin	Description
2	GND	1	CRT_RED
4	GND	3	CRT_GREEN
6	GND	5	CRT_BLUE
8	VGA_HSYNC	7	VGA_DDC_DATA
10	VGA_VSYNC	9	VGA_DDC_CLK

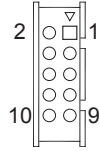

Board Top

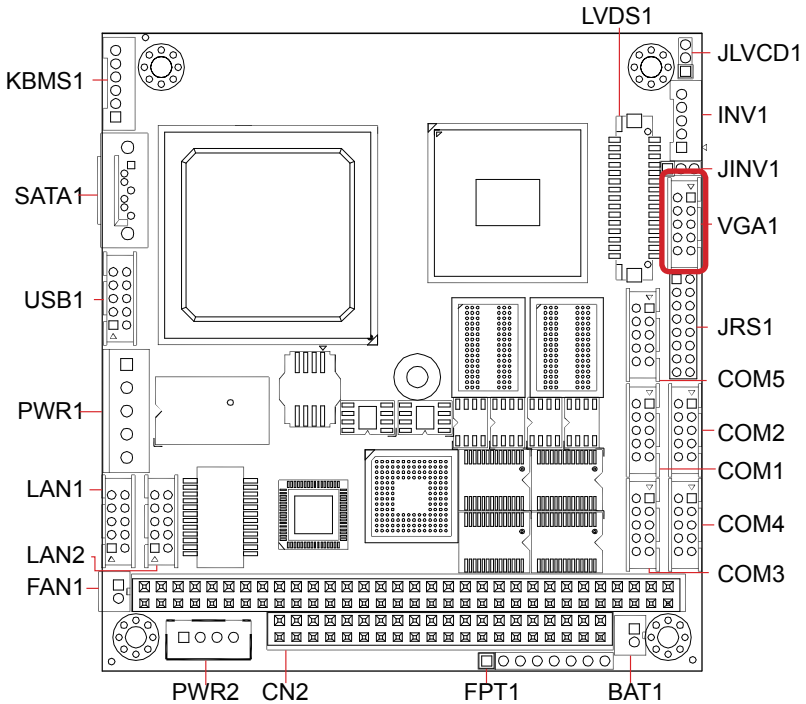

COM1~4

Description: Serial ports 1 to 4 (RS-232 and RS-485 configurable. See jumper [JRS1](#).)

Connector Type: 2.00mm pitch 2x5-pin header

Setting:

Pin	Description	Pin	Description
2	RX	1	DCD#
4	DTR#	3	TX#
6	DSR#	5	GND
8	CTS#	7	RTS#
10	N/C	9	RI#

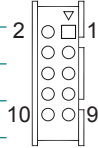

Board Top

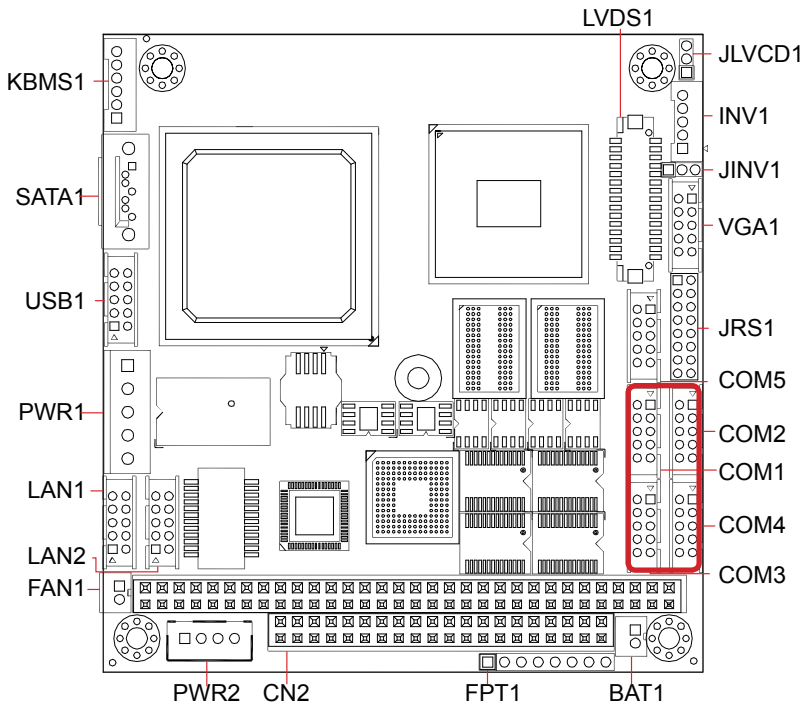

COM5

Description: RS485-interfaced serial port

Connector Type: 2.00mm pitch 2x5-pin header

Setting:

Pin	Description	Pin	Description
2	+DATA1	1	-DATA1
4	+DATA2	3	-DATA2
6	-DATA3	5	GND
8	-DATA4	7	+DATA3
10	N/C	9	+DATA4

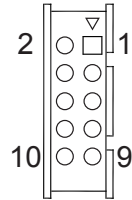

Board Top

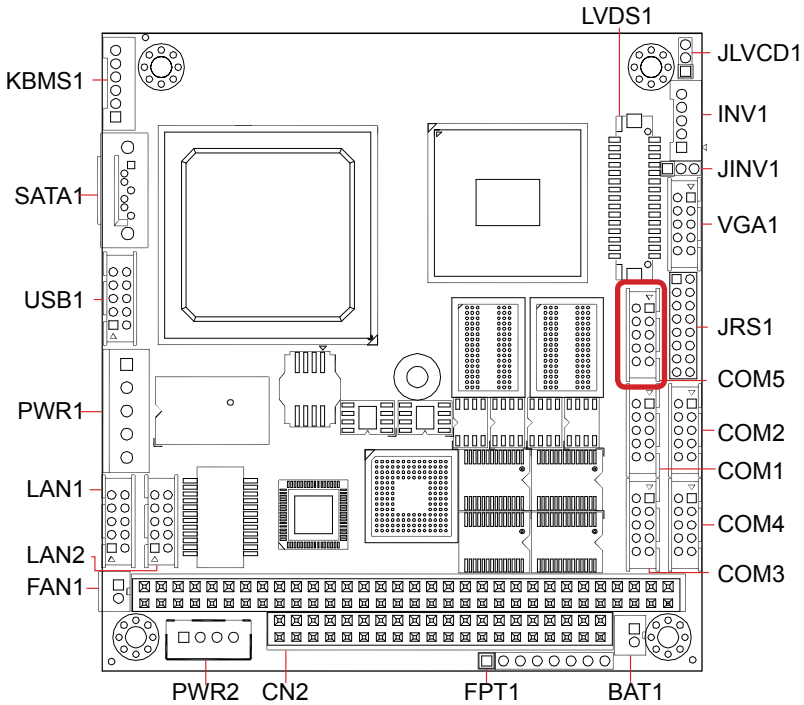

FPT1

Description: Connector for reset, power LED, HDD LED and speaker

Connector Type: 2.00mm pitch 1x8-pin header

Setting:

Pin	Description
1	RESET
2	GND
3	PWR LED+
4	GND
5	HDD LED+
6	HDD LED-
7	SPKOUT+
8	SPKOUT-

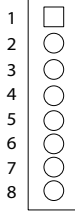

Board Top

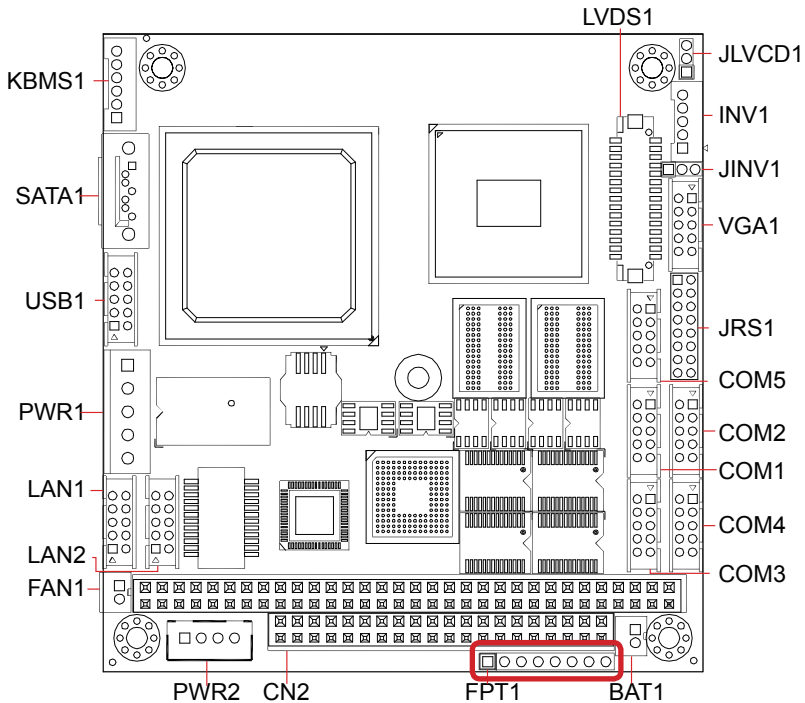

CN2

Description: PC/104 interface

Connector Type:

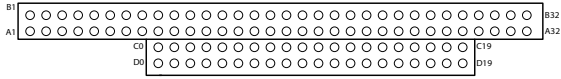

Board Top

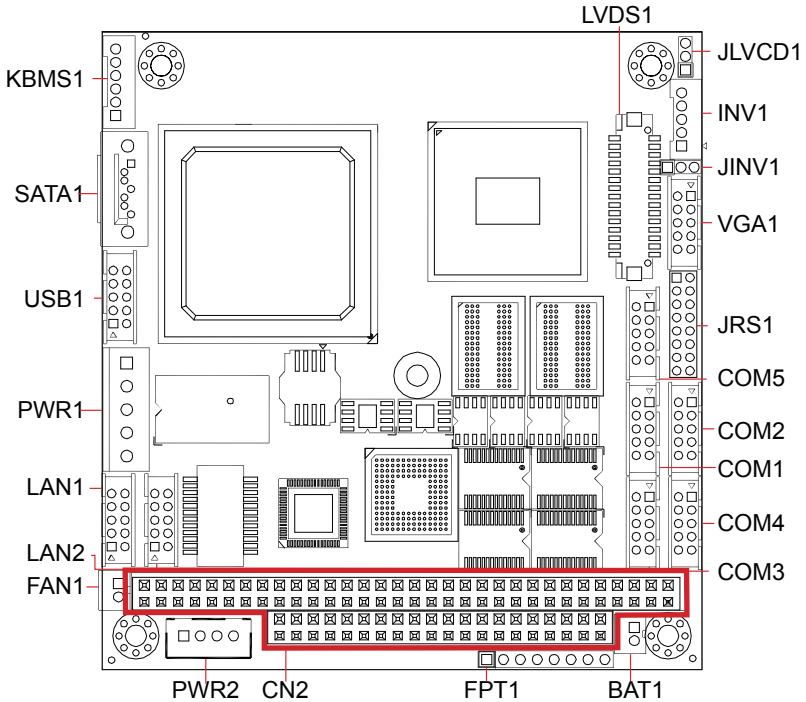

PWR1

Description: 12V/5V power input

Connector Type: 1x5-pin terminal

Setting:

Pin	Description
1	VCC 12V
2	GND
3	GND
4	VCC 5V
5	VCC 5V



Board Top

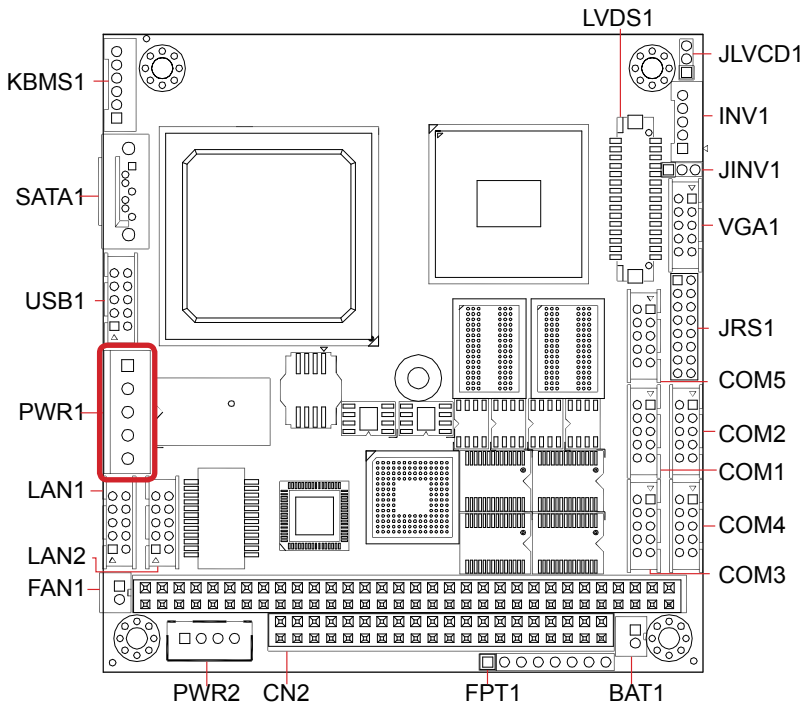

PWR2

Description: 5V power output

Connector Type: 2.54mm pitch 1x4-pin box wafer connector

Setting:

Pin	Description
1	VCC 5V
2	GND
3	GND
4	VCC 12V(From Pin1 of PWR1)

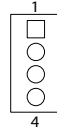

Board Top

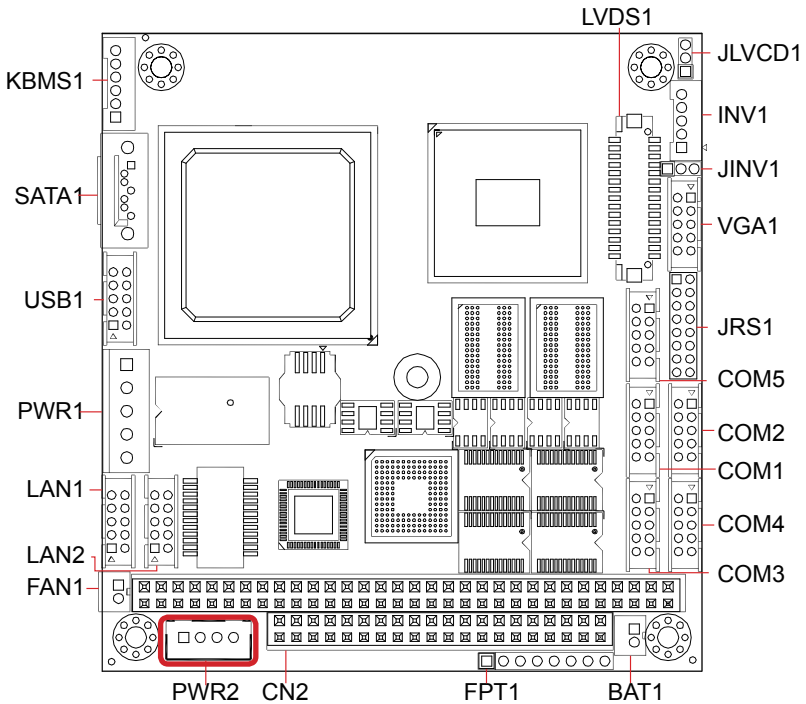

LAN1~2

Description: Ethernet connectors

Connector Type: 2.00mm pitch 2x5-pin headers

Setting:

Pin	Description	Pin	Description
2	TX_MDIO-	1	TX_MDIO+
4	MDI2+	3	RX_MDII+
6	RX_MDII-	5	MDI2-
8	MDI3-	7	MDI3+
10	N/C	9	N/C

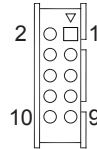

Board Top

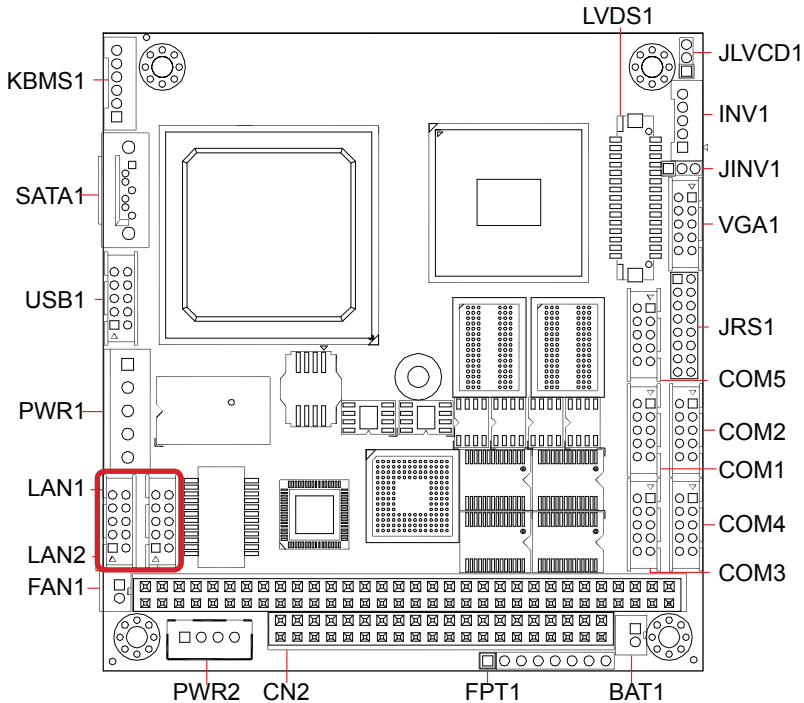

USB1

Description: Connectors for USB 0 and 1.

Connector Type: 2.00mm pitch 2x5-pin header

Setting:

Pin	Description	Pin	Description
2	+5V-	1	+5V
4	USBP1-	3	USBP0-
6	USBP1+	5	USBP0+
8	GND	7	GND
10	N/C	9	GND

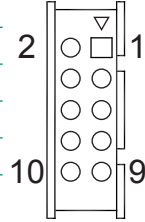

Board Top

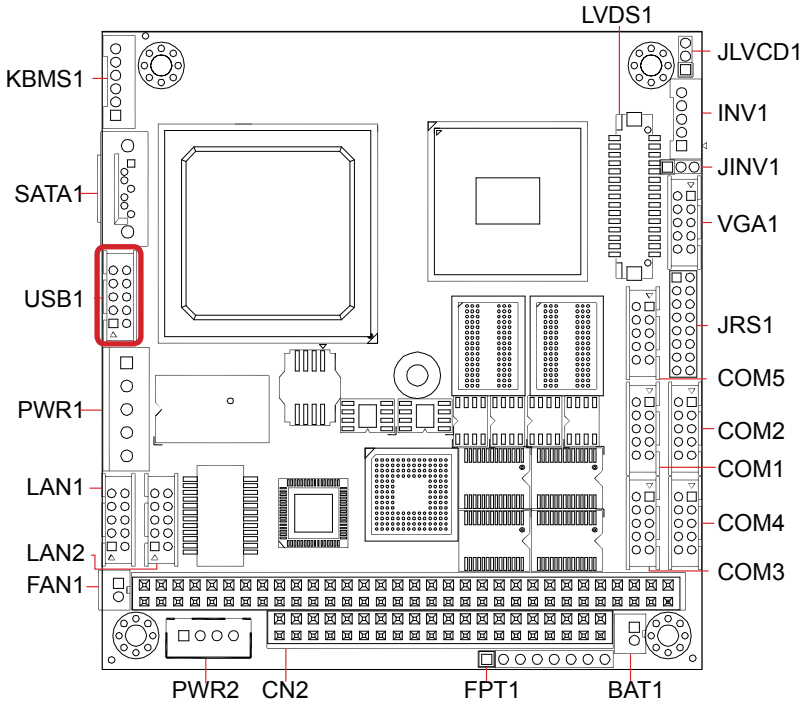

SATA1

Description: Serial ATA connector

Connector Type: High speed transfer rates (300MB/s).

Setting:

Pin	Description
1	GND
2	TX+
3	TX-
4	GND
5	RX-
6	RX+
7	GND



Board Top

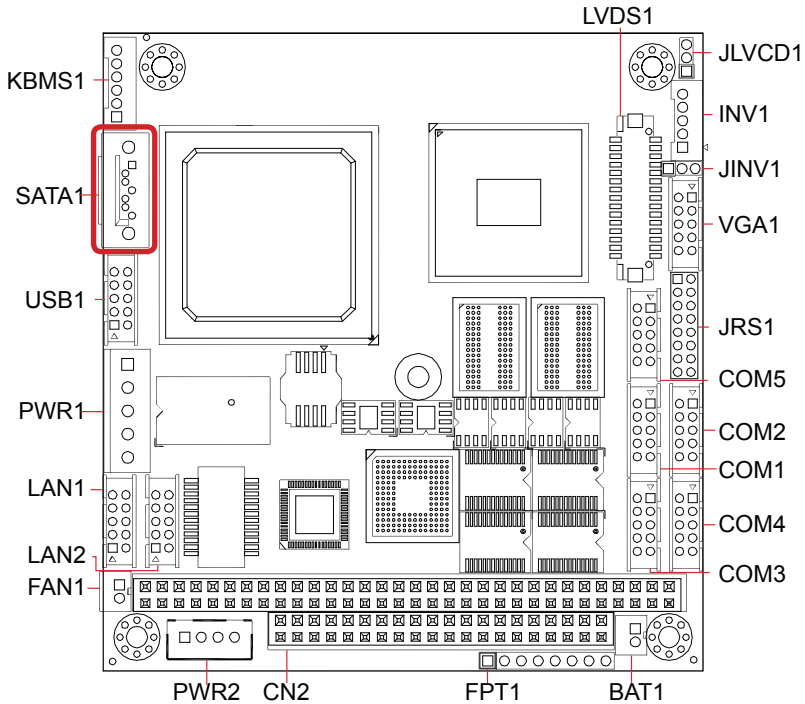

KBMS1

Description: Connector for keyboard and mouse.

Connector Type: 2.0mm pitch 1x6-pin header

Setting:

Pin	Description
1	KB_DATA
2	GND
3	MS_DATA
4	KB_CLK
5	PS2_VCC
6	MS_CLK

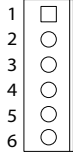

Board Top

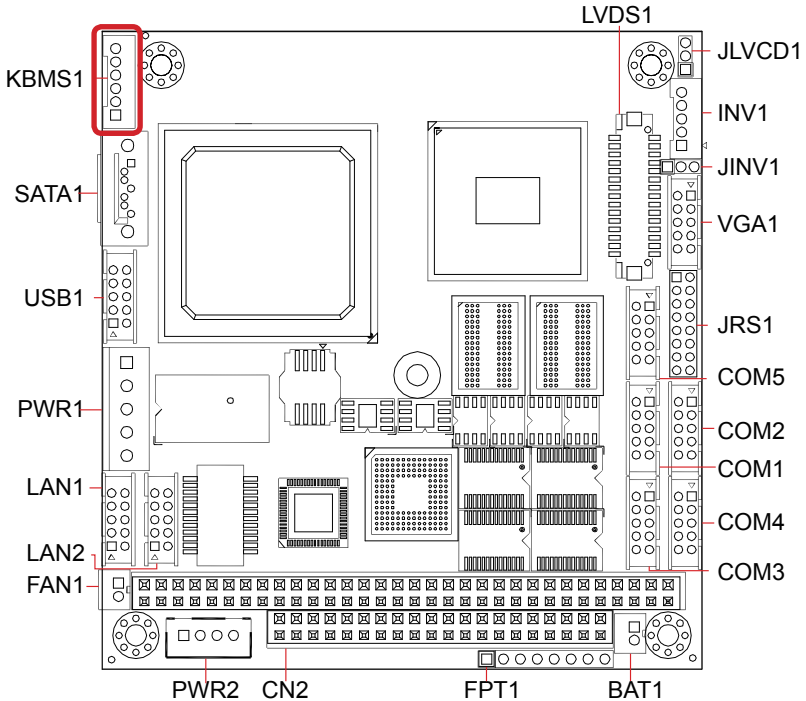

LVDS1

Description: Connector for LCD panel.

Connector Type: DF-13-30DP-1.25V connector

Setting:

Pin	Desc.	Pin	Desc.	Pin	Desc.
2	VDD	22	N/C	11	TX1D0-
4	N/C	24	N/C	13	GND
6	N/C	26	GND	15	TX1D1+
8	GND	28	N/C	17	TX1D1-
10	N/C	30	N/C	19	GND
12	N/C	1	VDD	21	TX1D2+
14	GND	3	TX1CLK+	23	TX1D2-
16	N/C	5	TX1CLK-	25	GND
18	N/C	7	GND	27	N/C
20	GND	9	TX1D0+	29	N/C

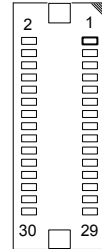

Board Top

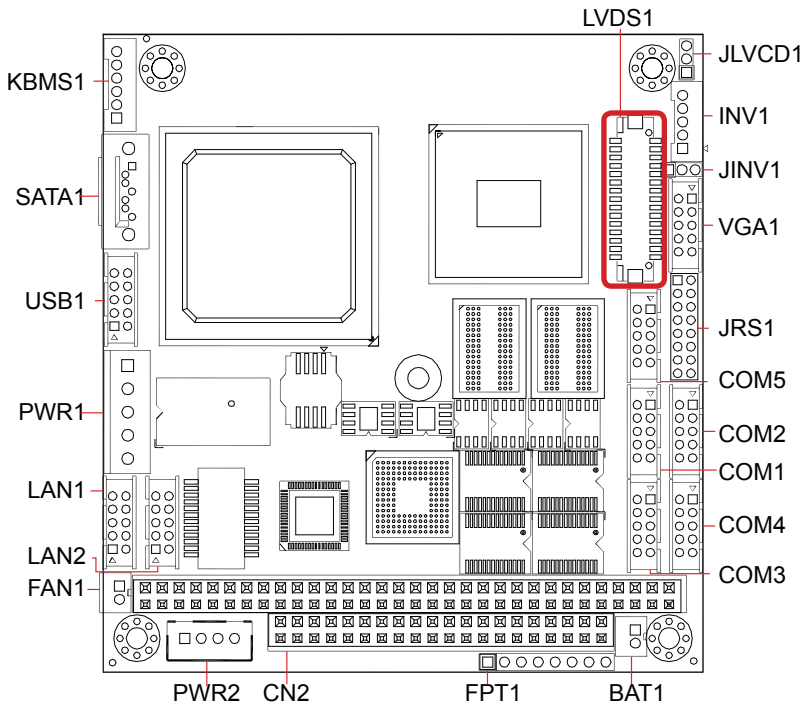

2.4. Driver Installation Notes

The CPU board supports Windows XP and Windows 7. Find the necessary drivers on the CD that comes with your purchase. For different OS, the driver/utility installation may vary slightly, but generally they are similar. **DO** follow the sequence below to install all drivers to prevent errors:

Chipset → Graphics → LAN → AHCI

Find the drivers on CD by the following paths:

Windows XP

Device	Driver Path
Chipset	\Em104-i290K\CHIPSET\Winxp\PVM infinst_autol_9.1.1.1020
VGA	\Em104-i290K\GRAPHICS\32\Graphics_WinXP_32_V6.14.10.5182 \Em104-i290K\GRAPHICS\64
LAN	\Em104-i290K\ETHERNET\32 \Em104-i290K\ETHERNET\64
AHCI	\Em104-i290K\AHCI

Windows 7

Device	Driver Path
Chipset	\Em104-i290K\CHIPSET\Win7\INF 9.1
VGA	\Em104-i290K\GRAPHICS\32 \Em104-i290K\GRAPHICS\64
LAN	\Em104-i290K\ETHERNET\32 \Em104-i290K\ETHERNET\64

Chapter 3

BIOS

BIOS

The BIOS Setup utility is featured by AMI BIOS to configure the system settings stored in the system's BIOS ROM. AMI BIOS is activated once the computer powers on.

After entering the utility, use the left/right arrow keys to navigate between the top menus and use the down arrow key to access one.

Menu	Description
Main	See 3.1. Main on page 29 .
Advanced	See 3.2. Advanced on page 30 .
Chipset	See 3.3. Chipset on page 40 .
PCIPnP	See 3.4. PCIPnP on page 44 .
Boot	See 3.5. Boot on page 46 .
Security	See 3.6. Security on page 47 .
Exit	See 3.7. Exit on page 48 .

NOTE: For system stability and performance, this BIOS utility is constantly improved. The screenshots demonstrated and descriptions hereinafter are for reference only and may not exactly meet what is presented onscreen.

3.1. Main

The **Main** menu displays some BIOS info and features the settings of **System Date** and **System Time**.

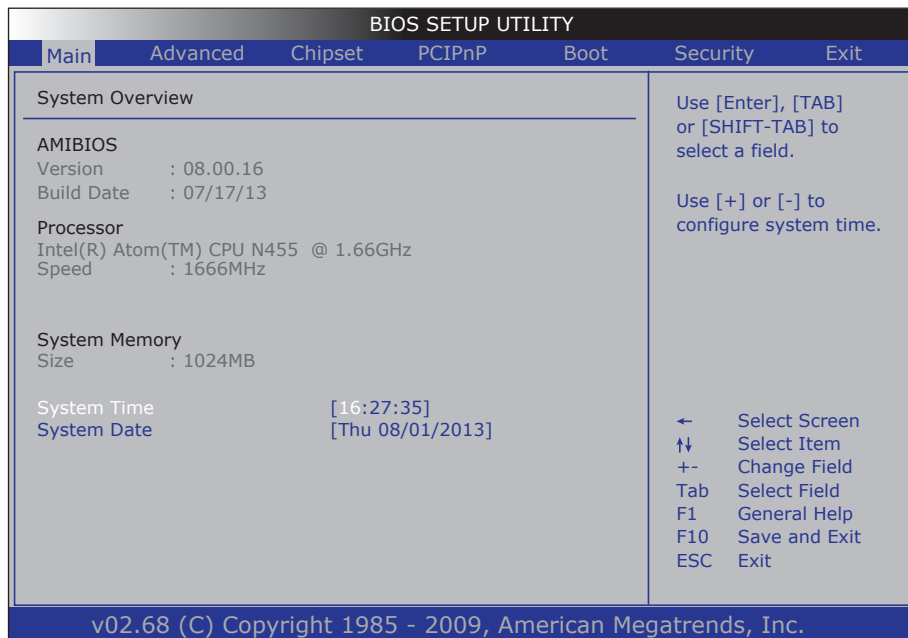

On **Main** menu, the BIOS info displayed is:

Category	Item	Description
AMIBIOS	Version	Displays BIOS version info
	Build Date	Displays the date the BIOS Setup utility was made/updated.
Processor		Displays processor info, which includes the following: ▶ Speed: The processor's max speed.
System Memory		Displays memory info, which includes the following: ▶ Size: The memory's capacity.

On **Main** menu, the featured settings are:

Setting	Description
System Time	Sets system time.
System Date	Sets system date.

3.2. Advanced

The **Advanced** menu controls the system’s CPU, IDE, Super IO, AHCI and USB. It also helps users monitor hardware health.

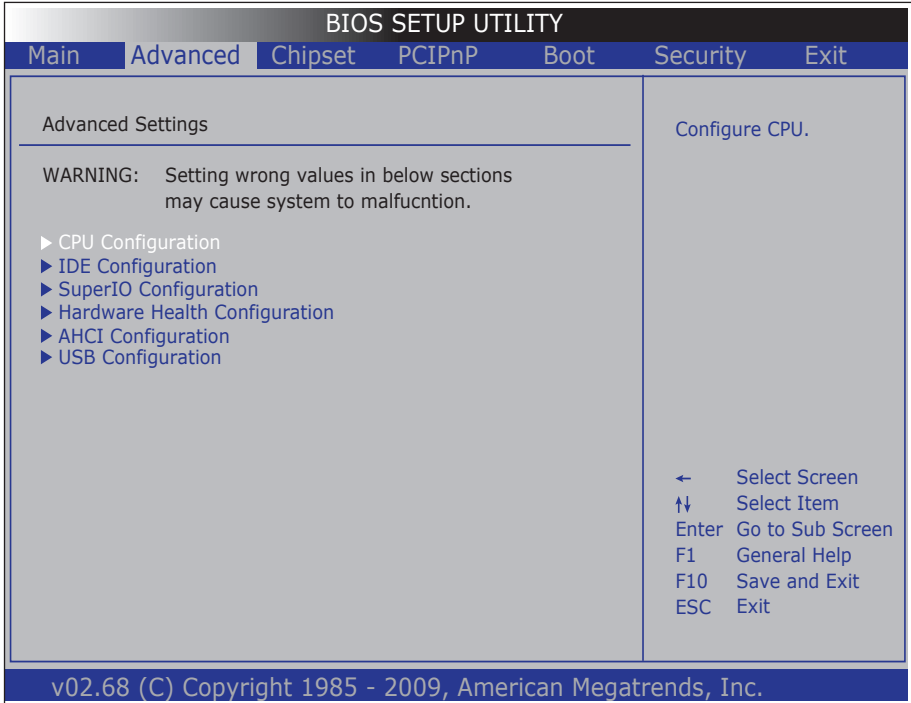

Featured submenus are:

Setting	Description
CPU Configuration	See 3.2.1. CPU Configuration on page 31 .
IDE Configuration	See 3.2.2. IDE Configuration on page 32 .
SuperIO Configuration	See 3.2.3. Super IO Configuration on page 35 .
Hardware Health Configuration	See 3.2.4. Hardware Health Configuration on page 37 .
AHCI Configuration	See 3.2.5. AHCI Configuration on page 38 .
USB Configuration	See 3.2.6. USB Configuration on page 39 .

3.2.1. CPU Configuration

This submenu enables viewing the detailed CPU info. It also configures the CPU.

BIOS SETUP UTILITY	
Advanced	
Configure advanced CPU settings	
Manufacture: Intel Intel(R) Atom(TM) CPU N455 @ 1.66GHz Frequency : 1.66GHz FSB Speed : 666MHz Cache L1 : 24 KB Cache L2 : 512 KB Ratio Actual Value: 10	
Hyper Threading Technology	[Enabled]
Intel (R) SpeedStep(tm) tech	[Enabled]
Enabled for Windows XP and Linux4 (OS optimized for Hyper Threading Technology) and disabled for other OS (OS not optimized for Hyper-Threading Technology)	
← Select Screen ↑↓ Select Item +- Change Option F1 General Help F10 Save and Exit ESC Exit	
v02.68 (C) Copyright 1985 - 2009, American Megatrends, Inc.	

The featured settings are:

Setting	Description
Hyper Threading Technology	Enables/disables the processor's Hyper-threading feature. <ul style="list-style-type: none"> ▶ Select Enabled for Windows XP and Linux4. (These are the OS optimized for Hyper-threading Technology) ▶ Select Disabled for the other OS (, which are not optimized for Hyper-threading Technology). ▶ Enabled is the default. ▶ When disabled, only one thread per enabled core is enabled.
Intel(R) SpeedStep(tm) tech	Enables/disables SpeedStep™ technology for better power saving. <ul style="list-style-type: none"> ▶ SpeedStep™ is a technology built into some Intel® processors that allows the processor's clock speed to be dynamically changed by software. ▶ Enabled is the default.

3.2.2. IDE Configuration

Access this submenu to configure the system's IDE (Integrated Device Electronics) devices.

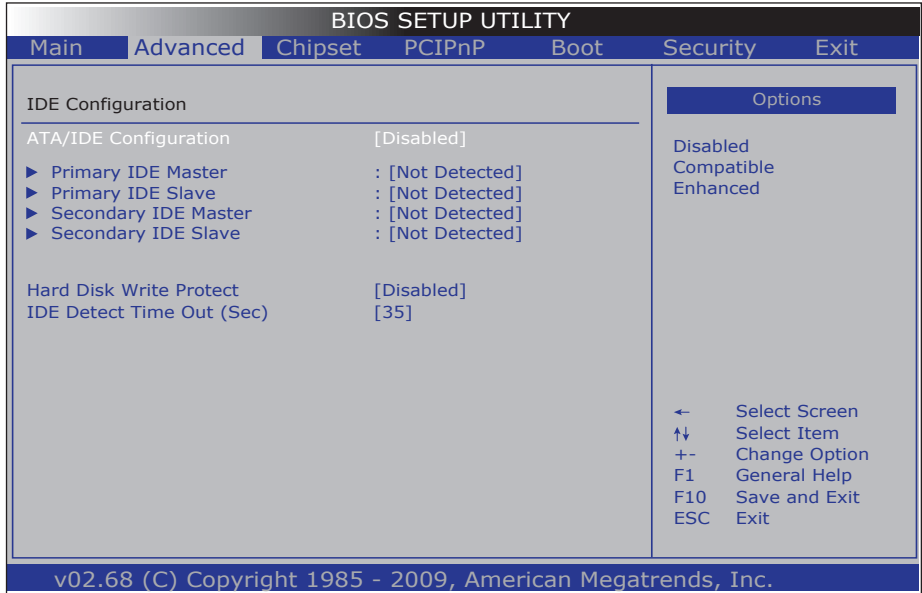

The featured settings are:

Setting	Description			
ATA/IDE Configuration	Configures the system's ATA/IDE port.			
	<ul style="list-style-type: none"> Available options are Disabled (default), Compatible and Enhanced. Select Compatible to have SATA as primary IDE channel and PATA as secondary. Leave the setting to Disabled to disable the ATA/IDE port. Select Enhanced to configure SATA channels to IDE or AHCI (Advanced Host Controller Interface). When set to Enhanced, the following setting becomes available: 			
	<table border="1"> <thead> <tr> <th>Setting</th> <th>Description</th> </tr> </thead> <tbody> <tr> <td>Configure SATA as</td> <td>Configures the SATA feature between IDE (default) and AHCI.</td> </tr> </tbody> </table>	Setting	Description	Configure SATA as
Setting	Description			
Configure SATA as	Configures the SATA feature between IDE (default) and AHCI .			

		Each channel features the following settings:	
		Setting	Description
Primary IDE Master	Type		Sets the type of the IDE device connected to the system, or leaves it on BIOS auto-detection. ▶ Available options are: Not Installed , Auto (default), CD/DVD , and ARMD , which means "ATAPI removable media device", a type of computing storage.
	LBA/Large Mode		Enables/disables LBA (logical block address) mode. ▶ Select Disabled to disable LBA mode. ▶ Select Auto to enable LBA mode if supported by the device and the device isn't formatted with LBA mode disabled. ▶ Auto is the default.
Primary IDE Slave	Block (Multi-Sector Transfer)		Sets whether the data transfer from/to the device occurs one sector or multiple sector at a time. ▶ Select Disabled to transfer data from/to the device one sector at a time. ▶ Select Auto to transfer data from/to the device multiple sectors at a time if supported by the device. ▶ Auto is the default.
	PIO Mode		Sets PIO (Programmed I/O) mode for the IDE drive, or leaves it on BIOS auto-configuration ▶ Available options are Auto (default), 0 , 1 , 2 , 3 , and 4 . ▶ Select Auto to let the BIOS auto-detect the IDE drive's maximum PIO mode supported.
Secondary IDE Master	DMA Mode		Configure the DMA (Direct Memory Address) feature, or leaves it on BIOS auto-detection ▶ Auto is the only available option.
	S.M.A.R.T.		Enables/disables S.M.A.R.T. (Self-Monitoring Analysis and Reporting Technology), or leaves it on BIOS auto-detection. ▶ S.M.A.R.T. is a utility to monitor the disk status to predict hard disk failure ▶ Available options are Auto (default), Disabled and Enabled .
Secondary IDE Slave	32Bit Data Transfer		Enables/disables 32-bit to maximize the IDE hard disk data transfer rate. ▶ Disabled is the default.

BIOS

Hard Disk Drive Write Protect	Enables/disables device write protection when the device is accessed through BIOS. ▶ Disabled is the default.
IDE Detect Time Out (Sec)	Sets the time-out (sec) for detecting ATA/ATAPI devices. ▶ Options available are: 0, 5, 10, 15, 20, 25, 30 and 35 (default).

3.2.3. Super IO Configuration

This submenu opens in context with the system's four serial ports, COM1 through COM4, to configure the Super IO chipset, F81865F.

BIOS SETUP UTILITY	
Advanced	
Configure F81865F Super IO Chipset	
Serial Port1 Address	[3F8]
Serial Port1 IRQ	[IRQ4]
Serial Port1 RS485	[Disabled]
Serial Port2 Address	[2F8]
Serial Port2 IRQ	[IRQ3]
Serial Port2 RS485	[Disabled]
Serial Port3 Address	[3E8]
Serial Port3 IRQ	[IRQ11]
Serial Port3 RS485	[Disabled]
Serial Port4 Address	[2E8]
Serial Port4 IRQ	[IRQ10]
Serial Port4 RS485	[Disabled]
<p>Allows BIOS To Select Serial Port1 Base Addresses.</p> <p>← Select Screen ↑↓ Select Item +- Change Option F1 General Help F10 Save and Exit ESC Exit</p>	
v02.68 (C) Copyright 1985 - 2009, American Megatrends, Inc.	

The featured settings are:

Setting	Description
Serial Port1 Address	Sets COM1 base addresses. ▶ Options available are: Disabled , 3F8 (default), 3E8 and 2E8 .
Serial Port1 IRQ	Sets COM1 IRQ. ▶ Options available are: IRQ3 , IRQ4 (default), IRQ10 , IRQ11 .
Serial Port1 RS485	Enables/disables COM1 to/from RS485. ▶ Disabled is the default.
Serial Port2 Address	Sets COM2 base addresses. ▶ Options available are: Disabled , 2F8 (default), 3E8 and 2E8 .
Serial Port2 IRQ	Sets COM2 IRQ. ▶ Options available are: IRQ3 (default), IRQ4 , IRQ10 , IRQ11 .
Serial Port2 RS485	Enables/disables COM2 to/from RS485. ▶ Disabled is the default.

Serial Port3 Address	Sets COM3 base addresses. ▶ Options available are: Disabled , 3F8 , 2F8 , 3E8 (default) and 2E8 .
Serial Port3 IRQ	Sets COM3 IRQ. ▶ Options available are: IRQ3 , IRQ4 , IRQ10 and IRQ11 (default).
Serial Port3 RS485	Enables/disables COM3 to/from RS485. ▶ Disabled is the default.
Serial Port4 Address	Sets COM4 base addresses. ▶ Options available are: Disabled , 3F8 , 2F8 , 3E8 and 2E8 (default).
Serial Port4 IRQ	Sets COM4 IRQ. ▶ Options available are: IRQ3 , IRQ4 , IRQ10 (default) and IRQ11 .
Serial Port4 RS485	Enables/disables COM4 to/from RS485. ▶ Disabled is the default.

3.2.4. Hardware Health Configuration

This submenu enables viewing the system’s hardware health status. It also features one setting to enable/disable hardware health monitoring function.

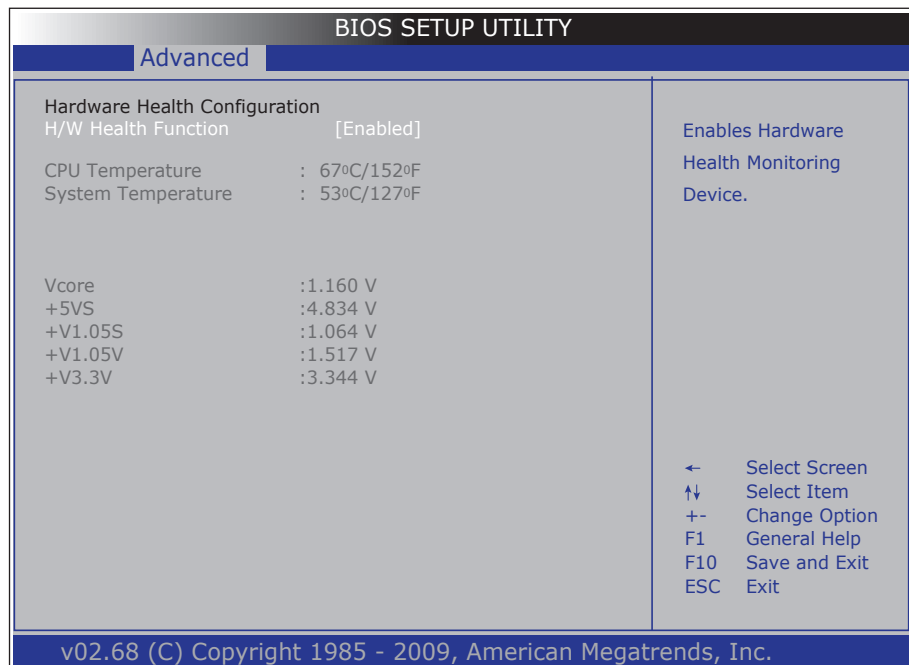

The featured setting is:

Setting	Description
H/W Health Function	Enables/disables the hardware health monitoring device. ▶ Enabled is the default.

3.2.5. AHCI Configuration

Access this submenu to view the presence of any IDE device. This submenu also configures the system's AHCI feature.

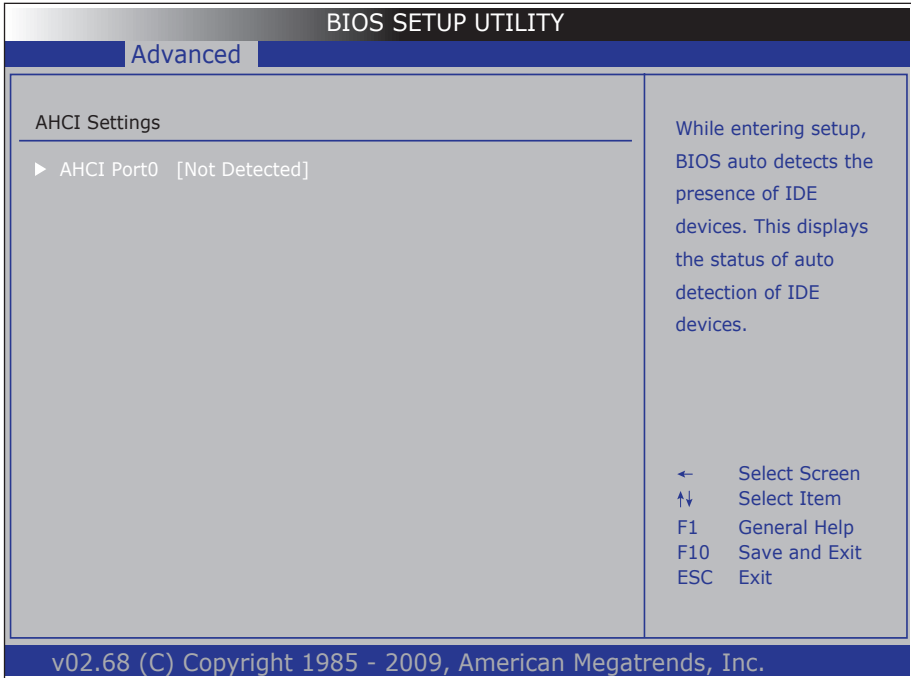

The featured submenu is:

Submenu	Description						
AHCI Port0	Opens the following settings:						
	<table border="1"> <thead> <tr> <th>Setting</th> <th>Description</th> </tr> </thead> <tbody> <tr> <td>SATA Port0</td> <td>Sets the type of the IDE device connected to the system, or leaves it on BIOS auto-detection. ▶ Available options are: Auto (default) and Not Installed.</td> </tr> <tr> <td>S.M.A.R.T.</td> <td>Enables/disables S.M.A.R.T. (Self-Monitoring Analysis and Reporting Technology). ▶ S.M.A.R.T. is a utility to monitor the disk status to predict hard disk failure ▶ Available options are Disabled and Enabled (default).</td> </tr> </tbody> </table>	Setting	Description	SATA Port0	Sets the type of the IDE device connected to the system, or leaves it on BIOS auto-detection. ▶ Available options are: Auto (default) and Not Installed .	S.M.A.R.T.	Enables/disables S.M.A.R.T. (Self-Monitoring Analysis and Reporting Technology). ▶ S.M.A.R.T. is a utility to monitor the disk status to predict hard disk failure ▶ Available options are Disabled and Enabled (default).
	Setting	Description					
SATA Port0	Sets the type of the IDE device connected to the system, or leaves it on BIOS auto-detection. ▶ Available options are: Auto (default) and Not Installed .						
S.M.A.R.T.	Enables/disables S.M.A.R.T. (Self-Monitoring Analysis and Reporting Technology). ▶ S.M.A.R.T. is a utility to monitor the disk status to predict hard disk failure ▶ Available options are Disabled and Enabled (default).						

3.2.6. USB Configuration

Access this submenu to view the USB module’s version and the USB device(s) enabled in the system. It also configures USB-related features.

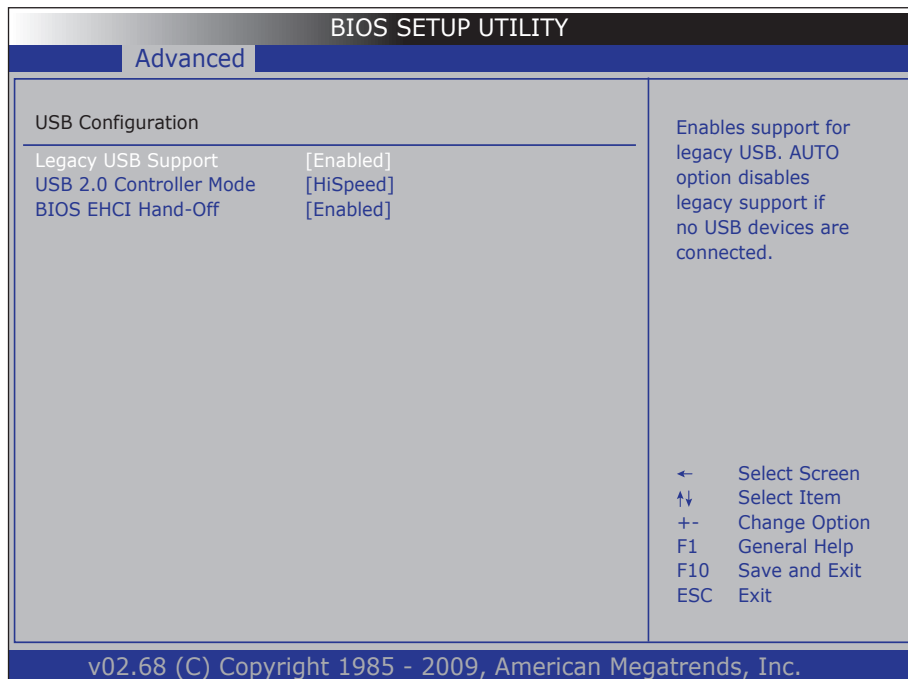

The featured settings are:

Setting	Description / Available Options
Legacy USB Support	Enables/disables legacy USB support including USB flash drives and USB hard drives. ▶ Options available are Disabled and Enabled (default).
USB 2.0 Controller Mode	Sets the USB 2.0 controller to HiSpeed (480Mbps) or FullSpeed (12Mbps). ▶ HiSpeed is the default.
BIOS EHCI Hand-Off	Enables/disables a workaround for the operating systems that have no EHCI hand-off support. ▶ Enabled is the default.

3.3. Chipset

This menu configures the system’s chipset-specific features that cover graphics, USB and LAN ports.

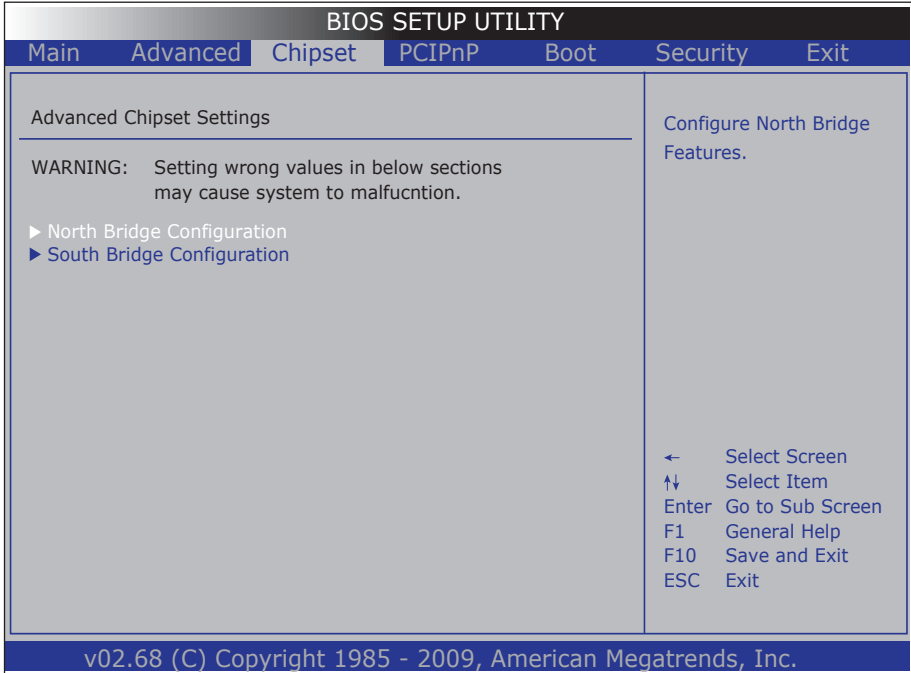

The featured submenus are:

Submenu	Description
North Bridge Configuration	Configures north bridge features. See 3.3.1. North Bridge Configuration on page 41.
South Bridge Configuration	Configures south bridge features. See 3.3.2. South Bridge Configuration on page 43.

WARNING: Wrong settings in these submenus may cause system malfunction.

3.3.1. North Bridge Configuration

This submenu configures the north bridge features by the following settings:

BIOS SETUP UTILITY	
Chipset	
North Bridge Chipset Configuration	
Initiate Graphic Adapter	[IGD]
Internal Graphics Mode Select	[Enabled, 8MB]
DVMT Mode Select	[DVMT Mode]
DVMT/FIXED Memory	[256MB]
Boot Display Device	[CRT + LVDS]
Flat Panel Type	[1024x768]
<p>Select which graphics controller to use as the primary boot device.</p> <p>← Select Screen ↑↓ Select Item +- Change Option F1 General Help F10 Save and Exit ESC Exit</p>	
v02.68 (C) Copyright 1985 - 2009, American Megatrends, Inc.	

The featured settings are:

Setting	Description
Initiate Graphic Adapter	Sets which graphics controller to use as the primary boot device. ▶ Options available are: IGD (default) and PCI/IGD .
Internal Graphics Mode Select	Sets the amount of system memory used by the internal graphics device. ▶ It is enabled by default and set to 8MB.
DVMT Mode Select	Sets how to allocate system memory to the CPU and graphics processor. ▶ Available options are: Fixed Mode: A fixed portion of graphics memory is reserved as graphics memory. DVMT Mode: The default. Graphics memory is dynamically allocated according to system and graphics needs.

DVMT/FIXED Memory	Sets the maximum amount of system memory that can be allocated as graphics memory. ▶ Available options are: 128MB , 256MB and Maximum DVMT .
Boot Display Device	Sets the display device during booting. ▶ Options available are: CRT , LVDS and CRT+LVDS .

3.3.2. South Bridge Configuration

This submenu configures the south bridge features by the following settings:

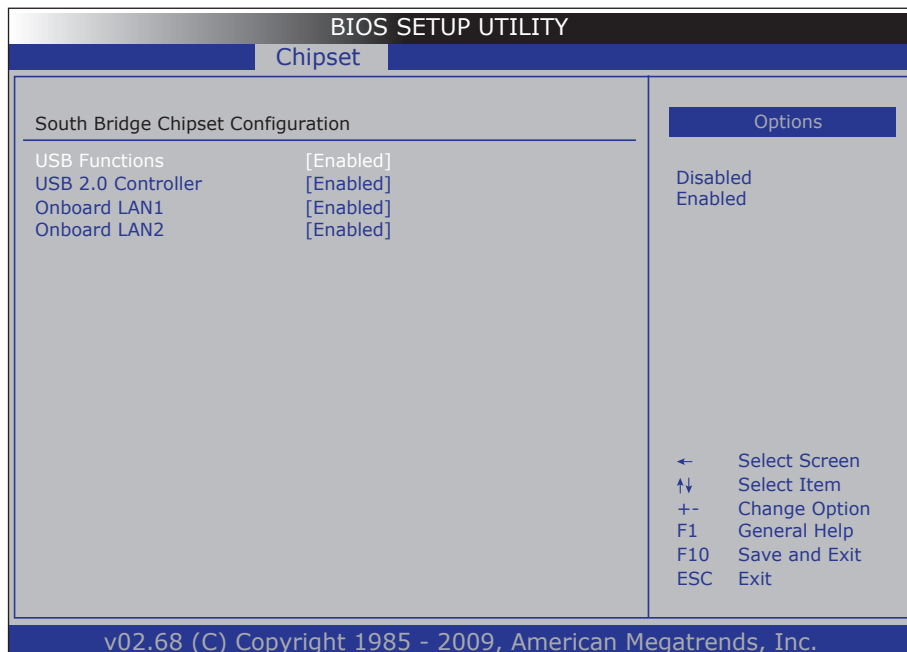

The featured settings are:

Setting	Description
USB Functions	Enables/disables the USB ports. ▶ Enabled is the default.
USB 2.0 Controller	Enables/disables USB 2.0 controller. ▶ Enabled is the default.
Onboard LAN1	Enables/disables LAN1 port. ▶ Enabled is the default.
Onboard LAN2	Enables/disables LAN2 port. ▶ Enabled is the default.

3.4. PCIPnP

Access **PCIPnP** menu to configure the system's PCI bus and Plug and Play (PnP) features.

BIOS SETUP UTILITY						
Main	Advanced	Chipset	PCIPnP	Boot	Security	Exit
Advanced PCI/PnP Settings				Available: Specified DMA is available to be used by PCI/PnP devices. Reserved: Specified DMA is reserved for use by Legacy ISA devices.		
WARNING: Setting wrong values in below sections may cause system to malfunction.						
Allocate IRQ to PCI VGA		[Yes]				
IRQ3		[Available]				
IRQ4		[Available]				
IRQ5		[Available]				
IRQ7		[Available]				
IRQ10		[Available]				
IRQ11		[Available]				
DMA Channel 0		[Available]		← Select Screen		
DMA Channel 1		[Available]		↑↓ Select Item		
DMA Channel 3		[Available]		+- Change Option		
DMA Channel 5		[Available]		F1 General Help		
DMA Channel 6		[Available]		F10 Save and Exit		
DMA Channel 7		[Available]		ESC Exit		
v02.68 (C) Copyright 1985 - 2009, American Megatrends, Inc.						

The featured settings are:

Setting	Description
Allocate IRQ to PCI VGA	Sets whether to assign IRQ to PCI VGA card if the card requests it. ▶ Options available are Yes (default) and No .
IRQ3	Sets whether to make the IRQ available to PCI/PnP devices or reserve it for legacy ISA devices. ▶ Options are Available (default) and Reserved .
IRQ4	
IRQ5	
IRQ7	
IRQ10	
IRQ11	

DMA Channel 0	<p>Sets whether to make the specified DMA channel available to PCI/PnP devices or reserve it to legacy ISA devices.</p> <ul style="list-style-type: none">▶ Options are Available (default) and Reserved.
DMA Channel 1	
DMA Channel 3	
DMA Channel 5	
DMA Channel 6	
DMA Channel 7	
DMA Channel 7	

3.5. Boot

Access this menu to change system boot settings.

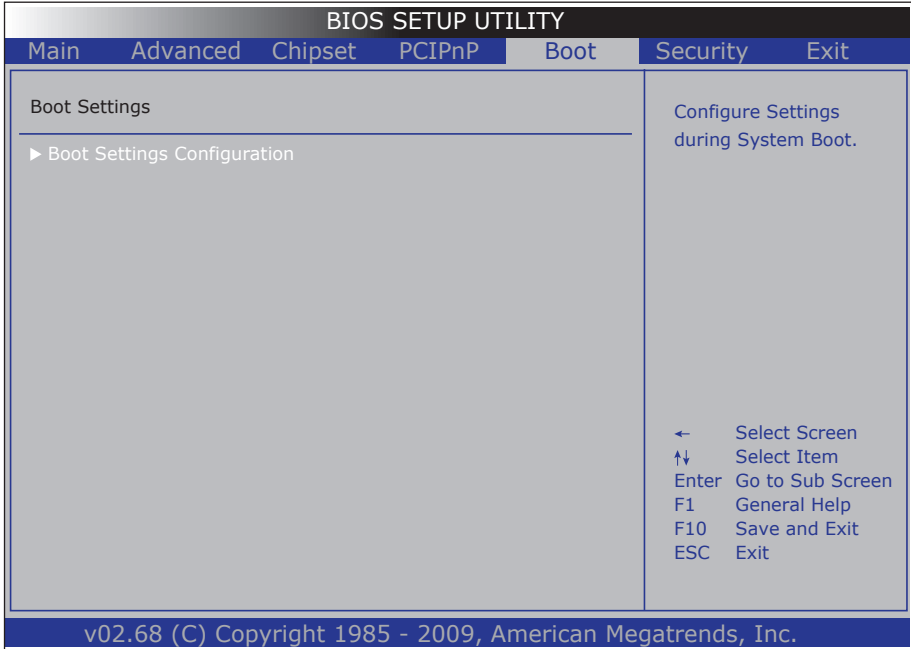

The featured submenu is:

Submenu	Description	
Boot Settings Configuration	Accesses the following settings:	
	Setting	Description
	Quick Boot	Allows the BIOS to skip certain test during booting, which will decrease the time to boot up the system. ▶ Enabled is the default.
	Quiet Boot	Sets whether to display the POST (power on self tests) messages or the system manufacturer's full screen logo during booting. ▶ Select Disabled to display the normal POST messages, which is the default setting.
	Bootup Num-Lock	Turns on/off keyboard Num-Lock during boot. ▶ On is the default.
LAN Boot Function	Enables/disables booting up the computer over the Ethernet. ▶ Disabled is the default.	

3.6. Security

Access this menu to view the current security settings used in the system. This menu also enables users to set up or change the security setting.

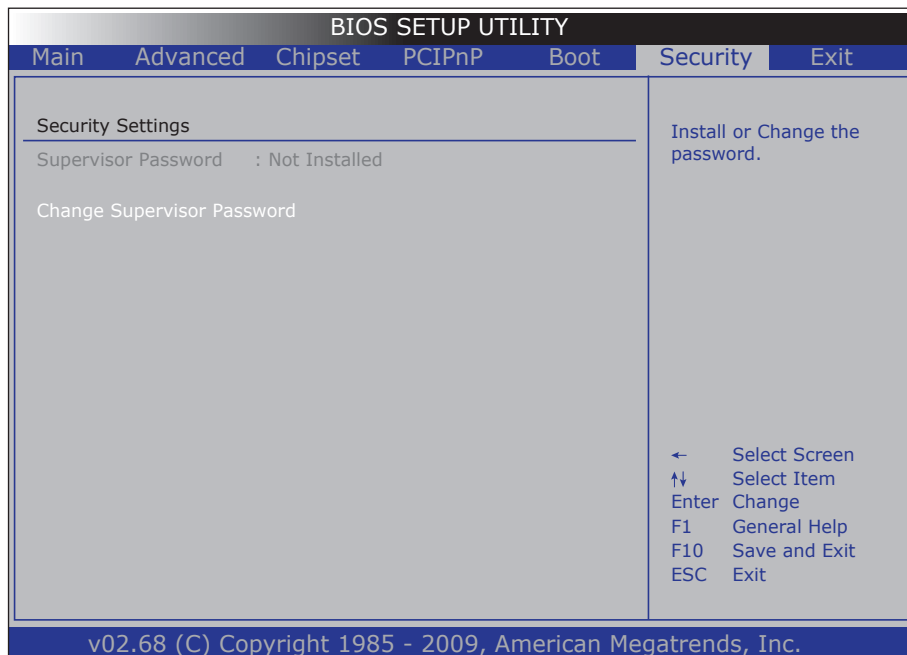

The featured settings are:

Setting	Description
Change Supervisor Password	Sets up or changes Supervisor password. <ul style="list-style-type: none"> ▶ Supervisor is a super user of the system who is able to administrate the system.
Password Check	Configures the password check. <ul style="list-style-type: none"> ▶ Select Setup to enable password check at each attempt to access the BIOS Setup utility. ▶ Select Always to enable password check at each system boot as well as at each attempt to access the BIOS Setup utility.

3.7. Exit

The **Exit** menu features a handful of commands to launch actions from the BIOS Setup utility regarding saving changes, quitting the utility and recovering defaults.

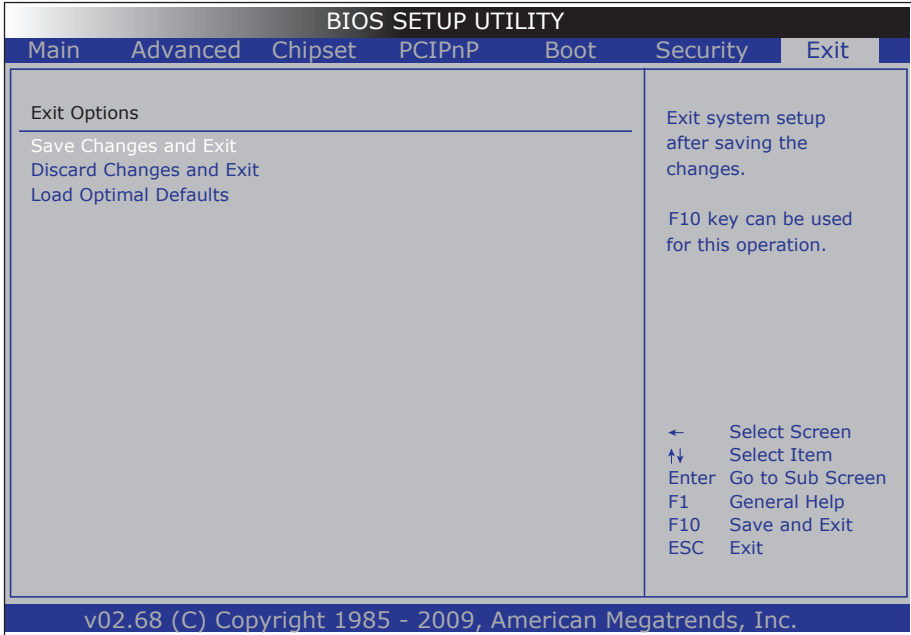

The featured settings are:

Setting	Description
Save Changes and Exit	<p>Saves the changes and quits the BIOS Setup utility.</p> <ul style="list-style-type: none"> ▶ This is a command to launch an action from the BIOS Setup utility. ▶ When prompted for confirmation, select OK to save the changes and quit the BIOS Setup, or select Cancel to return to BIOS Setup.
Discard Changes and Exit	<p>Discards the changes and quits the BIOS Setup utility.</p> <ul style="list-style-type: none"> ▶ This is a command to launch an action from the BIOS Setup utility. ▶ When prompted for confirmation, select OK to quit BIOS Setup without saving the change(s), or select Cancel to return to the BIOS setup.
Load Optimal Defaults	<p>Loads the defaults to all settings.</p> <ul style="list-style-type: none"> ▶ This is a command to launch an action from the BIOS Setup utility. ▶ When prompted for confirmation, select OK to load the defaults, or select Cancel to return to the BIOS setup.

Appendices

Appendix A. I/O Port Address Map

Each peripheral device in the system is assigned a set of I/O port addresses which also becomes the identity of the device. The following table lists the I/O port addresses used.

Address	Device Description
0x000003F8-0x000003FF	Communications Port (COM1)
0x000002F8-0x000002FF	Communications Port (COM2)
0x000003E8-0x000003EF	Communications Port (COM3)
0x0000DC00-0x0000DC1F	Ethernet Controller
0x000002E8-0x000002EF	Communications Port (COM4)
0x00000061-0x00000061	System speaker
0x00000000-0x00000CF7	PCI bus
0x00000000-0x00000CF7	Direct memory access controller
0x0000D000-0x0000FFFF	PCI bus
0x0000EC00-0x0000EC1F	Ethernet Controller
0x0000D000-0x0000DFFF	Intel(R) ICH8 Family PCI Express Root Port 2 - 2841
0x00000070-0x00000071	System CMOS/real time clock
0x0000E000-0x0000EFFF	Intel(R) ICH8 Family PCI Express Root Port 3 - 2843
0x00000010-0x0000001F	Motherboard resources
0x00000022-0x0000003F	Motherboard resources
0x00000044-0x0000005F	Motherboard resources
0x00000062-0x00000063	Motherboard resources
0x00000065-0x0000006F	Motherboard resources
0x00000072-0x0000007F	Motherboard resources
0x00000080-0x00000080	Motherboard resources
0x00000084-0x00000086	Motherboard resources
0x00000088-0x00000088	Motherboard resources
0x0000008C-0x0000008E	Motherboard resources
0x00000090-0x0000009F	Motherboard resources
0x000000A2-0x000000BF	Motherboard resources
0x000000E0-0x000000EF	Motherboard resources
0x000004D0-0x000004D1	Motherboard resources
0x00000800-0x0000087F	Motherboard resources

Address	Device Description
0x00000500-0x0000053F	Motherboard resources
0x00000A00-0x00000AE7	Motherboard resources
0x000000F0-0x000000FF	Numeric data processor
0x0000FFA0-0x0000FFAF	Intel(R) ICH8M 3 port Serial ATA Storage Controller - 2828
0x0000FF90-0x0000FF9F	Intel(R) ICH8M 3 port Serial ATA Storage Controller - 2828
0x0000C800-0x0000C807	Standard VGA Graphics Adapter
0x000003B0-0x000003BB	Standard VGA Graphics Adapter
0x000003C0-0x000003DF	Standard VGA Graphics Adapter
0x0000C880-0x0000C89F	Intel(R) ICH8 Family USB Universal Host Controller - 2830
0x00000020-0x00000021	Programmable interrupt controller
0x000000A0-0x000000A1	Programmable interrupt controller
0x00000040-0x00000043	System timer
0x000001F0-0x000001F7	ATA Channel 0
0x000003F6-0x000003F6	ATA Channel 0
0x00000081-0x00000083	Direct memory access controller
0x00000087-0x00000087	Direct memory access controller
0x00000089-0x0000008B	Direct memory access controller
0x0000008F-0x0000008F	Direct memory access controller
0x000000C0-0x000000DF	Direct memory access controller
0x00000170-0x00000177	ATA Channel 1
0x00000376-0x00000376	ATA Channel 1
0x00000060-0x00000060	Standard PS/2 Keyboard
0x00000064-0x00000064	Standard PS/2 Keyboard
0x00000400-0x0000041F	Intel(R) ICH8 Family SMBus Controller - 283E

Appendix B. Memory Address Map

Address	Device Description
0xFE8A0000-0xFE8BFFFF	Ethernet Controller
0xFE900000-0xFE9FFFFF	Ethernet Controller
0xFE89C000-0xFE89FFFF	Ethernet Controller
0xA0000-0xBFFFF	PCI bus
0xA0000-0xBFFFF	Standard VGA Graphics Adapter
0xD0000-0xDFFFF	PCI bus
0x3F700000-0xDFFFFFFF	PCI bus
0xF0000000-0xFED8FFFF	PCI bus
0xFEAA0000-0xFEABFFFF	Ethernet Controller
0xFEB00000-0xFEBFFFFF	Ethernet Controller
0xFE9C000-0xFE9FFFFF	Ethernet Controller
0xFE800000-0xFE9FFFFF	Intel(R) ICH8 Family PCI Express Root Port 2 - 2841
0x0000-0x9FFFF	System board
0xC0000-0xCFFFF	System board
0xE0000-0xFFFFF	System board
0x100000-0x3F6FFFFF	System board
0xFED90000-0xFFFFFFFF	System board
0xFED90000-0xFFFFFFFF	System board
0xFED14000-0xFED19FFF	System board
0xFEAA0000-0xFEBFFFFF	Intel(R) ICH8 Family PCI Express Root Port 3 - 2843
0xFEC00000-0xFEC00FFF	Motherboard resources
0xFEE00000-0xFEE00FFF	Motherboard resources
0xFED1C000-0xFED1FFFF	Motherboard resources
0xFED20000-0xFED3FFFF	Motherboard resources
0xFED40000-0xFED8FFFF	Motherboard resources
0xE0000000-0xFFFFFFFF	Motherboard resources
0xFFC00000-0xFFEFFFFF	Motherboard resources
0xFE700000-0xFE77FFFF	Standard VGA Graphics Adapter
0xD0000000-0xDFFFFFFF	Standard VGA Graphics Adapter
0xFE600000-0xFE6FFFFF	Standard VGA Graphics Adapter
0xFFB00000-0xFFBFFFFF	Intel(R) 82802 Firmware Hub Device
0xFFF00000-0xFFFFFFFF	Intel(R) 82802 Firmware Hub Device

Address	Device Description
0xFE580000-0xFE5FFFFF	Video Controller
0xFED00000-0xFED003FF	High precision event timer
0xFE7FF800-0xFE7FFBFF	Intel(R) ICH8 Family USB2 Enhanced Host Controller - 2836
0xFE7FFC00-0xFE7FFCFF	Intel(R) ICH8 Family SMBus Controller - 283E

Appendix C. Interrupt Request Lines (IRQ)

Peripheral devices use interrupt request lines to notify CPU for the service required. The following table shows the IRQ used by the devices on board.

Level	Function
IRQ 4	Communications Port (COM1)
IRQ 3	Communications Port (COM2)
IRQ 11	Communications Port (COM3)
IRQ 5	Ethernet Controller
IRQ 5	Ethernet Controller
IRQ 5	Intel(R) ICH8 Family SMBus Controller - 283E
IRQ 4294967292	Intel(R) ICH8 Family PCI Express Root Port 1 - 283F
IRQ 10	Communications Port (COM4)
IRQ 4294967294	Intel(R) ICH8 Family PCI Express Root Port 2 - 2841
IRQ 8	System CMOS/real time clock
IRQ 4294967293	Intel(R) ICH8 Family PCI Express Root Port 3 - 2843
IRQ 13	Numeric data processor
IRQ 81	Microsoft ACPI-Compliant System
IRQ 82	Microsoft ACPI-Compliant System
IRQ 83	Microsoft ACPI-Compliant System
IRQ 84	Microsoft ACPI-Compliant System
IRQ 85	Microsoft ACPI-Compliant System
IRQ 86	Microsoft ACPI-Compliant System
IRQ 87	Microsoft ACPI-Compliant System
IRQ 88	Microsoft ACPI-Compliant System
IRQ 89	Microsoft ACPI-Compliant System
IRQ 90	Microsoft ACPI-Compliant System
IRQ 91	Microsoft ACPI-Compliant System
IRQ 92	Microsoft ACPI-Compliant System
IRQ 93	Microsoft ACPI-Compliant System
IRQ 94	Microsoft ACPI-Compliant System
IRQ 95	Microsoft ACPI-Compliant System
IRQ 96	Microsoft ACPI-Compliant System
IRQ 97	Microsoft ACPI-Compliant System

Level	Function
IRQ 98	Microsoft ACPI-Compliant System
IRQ 99	Microsoft ACPI-Compliant System
IRQ 100	Microsoft ACPI-Compliant System
IRQ 101	Microsoft ACPI-Compliant System
IRQ 102	Microsoft ACPI-Compliant System
IRQ 103	Microsoft ACPI-Compliant System
IRQ 104	Microsoft ACPI-Compliant System
IRQ 105	Microsoft ACPI-Compliant System
IRQ 106	Microsoft ACPI-Compliant System
IRQ 107	Microsoft ACPI-Compliant System
IRQ 108	Microsoft ACPI-Compliant System
IRQ 109	Microsoft ACPI-Compliant System
IRQ 110	Microsoft ACPI-Compliant System
IRQ 111	Microsoft ACPI-Compliant System
IRQ 112	Microsoft ACPI-Compliant System
IRQ 113	Microsoft ACPI-Compliant System
IRQ 114	Microsoft ACPI-Compliant System
IRQ 115	Microsoft ACPI-Compliant System
IRQ 116	Microsoft ACPI-Compliant System
IRQ 117	Microsoft ACPI-Compliant System
IRQ 118	Microsoft ACPI-Compliant System
IRQ 119	Microsoft ACPI-Compliant System
IRQ 120	Microsoft ACPI-Compliant System
IRQ 121	Microsoft ACPI-Compliant System
IRQ 122	Microsoft ACPI-Compliant System
IRQ 123	Microsoft ACPI-Compliant System
IRQ 124	Microsoft ACPI-Compliant System
IRQ 125	Microsoft ACPI-Compliant System
IRQ 126	Microsoft ACPI-Compliant System
IRQ 127	Microsoft ACPI-Compliant System
IRQ 128	Microsoft ACPI-Compliant System
IRQ 129	Microsoft ACPI-Compliant System
IRQ 130	Microsoft ACPI-Compliant System
IRQ 131	Microsoft ACPI-Compliant System

Level	Function
IRQ 132	Microsoft ACPI-Compliant System
IRQ 133	Microsoft ACPI-Compliant System
IRQ 134	Microsoft ACPI-Compliant System
IRQ 135	Microsoft ACPI-Compliant System
IRQ 136	Microsoft ACPI-Compliant System
IRQ 137	Microsoft ACPI-Compliant System
IRQ 138	Microsoft ACPI-Compliant System
IRQ 139	Microsoft ACPI-Compliant System
IRQ 140	Microsoft ACPI-Compliant System
IRQ 141	Microsoft ACPI-Compliant System
IRQ 142	Microsoft ACPI-Compliant System
IRQ 143	Microsoft ACPI-Compliant System
IRQ 144	Microsoft ACPI-Compliant System
IRQ 145	Microsoft ACPI-Compliant System
IRQ 146	Microsoft ACPI-Compliant System
IRQ 147	Microsoft ACPI-Compliant System
IRQ 148	Microsoft ACPI-Compliant System
IRQ 149	Microsoft ACPI-Compliant System
IRQ 150	Microsoft ACPI-Compliant System
IRQ 151	Microsoft ACPI-Compliant System
IRQ 152	Microsoft ACPI-Compliant System
IRQ 153	Microsoft ACPI-Compliant System
IRQ 154	Microsoft ACPI-Compliant System
IRQ 155	Microsoft ACPI-Compliant System
IRQ 156	Microsoft ACPI-Compliant System
IRQ 157	Microsoft ACPI-Compliant System
IRQ 158	Microsoft ACPI-Compliant System
IRQ 159	Microsoft ACPI-Compliant System
IRQ 160	Microsoft ACPI-Compliant System
IRQ 161	Microsoft ACPI-Compliant System
IRQ 162	Microsoft ACPI-Compliant System
IRQ 163	Microsoft ACPI-Compliant System
IRQ 164	Microsoft ACPI-Compliant System

Level	Function
IRQ 165	Microsoft ACPI-Compliant System
IRQ 166	Microsoft ACPI-Compliant System
IRQ 167	Microsoft ACPI-Compliant System
IRQ 168	Microsoft ACPI-Compliant System
IRQ 169	Microsoft ACPI-Compliant System
IRQ 170	Microsoft ACPI-Compliant System
IRQ 171	Microsoft ACPI-Compliant System
IRQ 172	Microsoft ACPI-Compliant System
IRQ 173	Microsoft ACPI-Compliant System
IRQ 174	Microsoft ACPI-Compliant System
IRQ 175	Microsoft ACPI-Compliant System
IRQ 176	Microsoft ACPI-Compliant System
IRQ 177	Microsoft ACPI-Compliant System
IRQ 178	Microsoft ACPI-Compliant System
IRQ 179	Microsoft ACPI-Compliant System
IRQ 180	Microsoft ACPI-Compliant System
IRQ 181	Microsoft ACPI-Compliant System
IRQ 182	Microsoft ACPI-Compliant System
IRQ 183	Microsoft ACPI-Compliant System
IRQ 184	Microsoft ACPI-Compliant System
IRQ 185	Microsoft ACPI-Compliant System
IRQ 186	Microsoft ACPI-Compliant System
IRQ 187	Microsoft ACPI-Compliant System
IRQ 188	Microsoft ACPI-Compliant System
IRQ 189	Microsoft ACPI-Compliant System
IRQ 190	Microsoft ACPI-Compliant System
IRQ 23	Intel(R) ICH8 Family USB Universal Host Controller - 2830
IRQ 23	Intel(R) ICH8 Family USB2 Enhanced Host Controller - 2836
IRQ 0	System timer
IRQ 14	ATA Channel 0
IRQ 15	ATA Channel 1
IRQ 1	Standard PS/2 Keyboard

Appendices

Level	Function
IRQ0	Interval timer
IRQ1	Keyboard
IRQ2	Interrupt from controller 2 (cascade)
IRQ3	COM2
IRQ4	COM1
IRQ5	Reserved
IRQ6	Reserved
IRQ7	Reserved
IRQ8	RTC
IRQ9	Reserved
IRQ10	Reserved
IRQ11	Reserved
IRQ12	PS/2 mouse
IRQ13	Math coprocessor
IRQ14	Primary IDE
IRQ15	Secondary IDE

Appendix D. DMA Map

DMA Channel	Device Description
4	Direct memory access controller

Appendix E: Watchdog Timer (WDT) Setting

WDT is widely used for industrial application to monitor CPU activities. The application software depends on its requirement to trigger WDT with adequate timer setting. Before WDT timeout, the functional normal system will reload the WDT. The WDT never time-out for a normal system. The WDT will not be reloaded by an abnormal system, then WDT will time-out and auto-reset the system to avoid abnormal operation.

This computer supports 255 levels watchdog timer by software programming I/O ports.

Below is an assembly program example to disable and load WDT.

Sample Codes:

```

/*----- Include Header Area -----*/
#include "math.h"
#include "stdio.h"
#include "dos.h"

#define SIO_INDEX      0x2E          /* or index = 0x4E */
#define SIO_DATA      0x2F          /* or data  = 0x4F */

/*----- routing, sub-routing -----*/
void main()
{
    outportb(SIO_INDEX, 0x87);        /* SIO - Enable */
    outportb(SIO_INDEX, 0x87);

    outportb(SIO_INDEX, 0x07);        /* LDN - WDT */
    outportb(SIO_DATA,  0x07);

    outportb(SIO_INDEX, 0x30);        /* WDT - Enable */
    outportb(SIO_DATA,  0x01);

    outportb(SIO_INDEX, 0xF6);        /* WDT - Timeout Value : 5sec */
    outportb(SIO_DATA,  0x05);

    outportb(SIO_INDEX, 0xFA);        /* WDOUT - Enable */
    outportb(SIO_DATA,  0x01);

    outportb(SIO_INDEX, 0xF5);        /* WDT - Configuration */
    outportb(SIO_DATA,  0x31);

    outportb(SIO_INDEX, 0xAA);        /* SIO - Disable */
}

```