EmCORE-i9457

3.5" Embedded Board

User's Manual

Version 1.1

This page is intentionally left blank.

Table of Contents

Chapter 1- Introduction..... 1

- 1.1 Copyright Notice.....2**
- 1.2 About this User’s Manual.....2**
- 1.3 Warning2**
- 1.4 Replacing the lithium battery3**
- 1.5 Technical Support.....3**
- 1.6 Warranty4**
- 1.7 Packing List.....5**
- 1.8 Ordering Information.....5**
- 1.9 Specifications6**
- 1.10 Board Dimensions7**
- 1.11 Installing the CPU9**
- 1.12 Installing the Memory.....10**
- 1.13 Heatsink Installation..... 11**
- 1.14 Heatsink Dimensions12**

Chapter 2- Installation..... 13

- 2.2 Jumpers and Connectors 15**
- Jumpers.....16**
 - JRS2: COM2 RS-232/422/485 Mode Select..... 16**
 - LV3, LV4: COM2 Power source Special Support..... 16**
 - JBAT1: Clear CMOS Setup..... 17**
 - JVLCD1: LCD Panel Voltage Select..... 17**
- Connectors.....18**
 - INV1: LCD Inverter Connector 18**
 - SATA1: Serial ATA Connector..... 18**
 - LPT1: Parallel Port or FDD Connector..... 19**
 - JFRT1: Switches20**
 - IDE1: Primary IDE Connector21**
 - USB2/ USB3: USB Connectors.....22**
 - JSMB1: External SMBUS Connector22**
 - JCOM2: RS-422/ 485 Output Connector22**
 - COM2: RS-232 Connector.....23**
 - AUDIO1: Front Panel AUDIO Connector.....23**

MINIPCI1: MiniPCI slot	23
USB1: USB Connector	24
LAN1: RJ-45 connector	24
KBM1: Keyboard & Mouse	24
VGA1: CRT Connector	25
COM1: RS232 Connector	25
ATX1: ATX Power Supply Connector	26
CPUF1: CPU Fan Power Connector	26
LVDS1: LVDS LCD Connector.....	27
CFD1: Compact Flash II Socket.....	28
2.3 The Installation Paths of CD Driver.....	29
Chapter 3- BIOS	31
3.1 BIOS Introduction	32
3.2 BIOS Setup	32
3.3 Standard CMOS Features	33
3.4 Advance BIOS Features	36
3.5 Advanced Chipset Features	39
3.6 Integrated Peripherals	41
3.7 Power Management Setup.....	44
3.8 PNP/PCI Configurations.....	46
3.9 PC Health Status.....	48
3.10 Load Optimized Defaults	49
3.11 Set Password	50
3.12 Save & Exit Setup	51
3.13 Exit Without Saving.....	52
3.14 BIOS Beep Sound code list	53
3.15 BIOS memory mapping.....	53
3.16 Award BIOS Post Codes	54
Chapter 4- Appendix	59
4.1 I/O Port Address Map	60
4.2 Interrupt Request Lines (IRQ).....	62
4.3 Memory Resources.....	63



Chapter 1

Introduction

1.1 Copyright Notice

All Rights Reserved.

The information in this document is subject to change without prior notice in order to improve the reliability, design and function. It does not represent a commitment on the part of the manufacturer.

Under no circumstances will the manufacturer be liable for any direct, indirect, special, incidental, or consequential damages arising from the use or inability to use the product or documentation, even if advised of the possibility of such damages.

This document contains proprietary information protected by copyright. All rights are reserved. No part of this manual may be reproduced by any mechanical, electronic, or other means in any form without prior written permission of the manufacturer.

1.2 About this User's Manual

This User's Manual is intended for experienced users and integrators with hardware knowledge of personal computers. If you are not sure about any description in this User's Manual, please consult your vendor before further handling.

1.3 Warning

Single Board Computers and their components contain very delicate Integrated Circuits (IC). To protect the Single Board Computer and its components against damage from static electricity, you should always follow the following precautions when handling it :

1. Disconnect your Single Board Computer from the power source when you want to work on the inside.
2. Hold the board by the edges and try not to touch the IC chips, leads or circuitry.
3. Use a grounded wrist strap when handling computer components.
4. Place components on a grounded antistatic pad or on the bag that came with the Single Board Computer, whenever components are separated from the system.

1.4 Replacing the lithium battery

Incorrect replacement of the lithium battery may lead to a risk of explosion. The lithium battery must be replaced with an identical battery or a battery type recommended by the manufacturer.

Do not throw lithium batteries into the trashcan. It must be disposed of in accordance with local regulations concerning special waste.

1.5 Technical Support

If you have any technical difficulties, please consult the user's manual first at:

<ftp://ftp.arbor.com.tw/pub/manual>

Please do not hesitate to call or e-mail our customer service when you still can not find out the answer.

<http://www.arbor.com.tw>

E-mail: info@arbor.com.tw

1.6 Warranty

This product is warranted to be in good working order for a period of two years from the date of purchase. Should this product fail to be in good working order at any time during this period, we will, at our option, replace or repair it at no additional charge except as set forth in the following terms. This warranty does not apply to products damaged by misuse, modifications, accident or disaster.

Vendor assumes no liability for any damages, lost profits, lost savings or any other incidental or consequential damage resulting from the use, misuse of, or inability to use this product. Vendor will not be liable for any claim made by any other related party.

Vendors disclaim all other warranties, either expressed or implied, including but not limited to implied warranties of merchantability and fitness for a particular purpose, with respect to the hardware, the accompanying product's manual(s) and written materials, and any accompanying hardware. This limited warranty gives you specific legal rights.

Return authorization must be obtained from the vendor before returned merchandise will be accepted. Authorization can be obtained by calling or faxing the vendor and requesting a Return Merchandise Authorization (RMA) number. Returned goods should always be accompanied by a clear problem description.

1.7 Packing List



1x EmCORE-i9457 3.5" Embedded Board



1x Driver CD



1x Quick Installation Guide

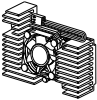

1 x CPU Cooler



1 x ATX Power cable
ATX main power connector (2x10 pins) to EmCORE-i9457 power connector (2x5 pins)

If any of the above items is damaged or missing, contact your vendor immediately.

1.8 Ordering Information

EmCORE-i9457VLG	3.5" Intel 65nm μ FC-PGA Core™ Duo/Core™ 2 Duo/Celeron M (667MHz) Embedded Board with CRT/LCD, Audio and Gb LAN
Cable kit	CBK-08-9457-00 1 x Audio Cable 1 x COM Port Cable 1 x LPT to FDD Cable 1 x IDE Cable 1 x LPT Cable 1 x Keyboard & mouse Cable 1 x SATA Cable 2 x USB Cable

1.9 Specifications

Form Factor	3.5" Embedded Board
CPU	Supports socket mPGA 478 for Intel® Core™ 2 Duo/ Core™ Duo/ Celeron M (FSB 667MHz)
Chipset	Intel® 945GME + Intel® ICH7M
System Memory	1 x 200-pin SO-DIMM socket up to 2GB DDRII 400/533/667 SDRAM
VGA/ LCD Controller	Intel® Graphics Media Accelerator (GMA) 950 graphics core w/ CRT/ Dual Channel LVDS (Dual independent display)
Ethernet	1 x RTL8111B PCIe 10/100/1000 Base-T Ethernet
I/O Chips	WINBOND W83627
BIOS	Phoenix-Award PnP Flash BIOS
Audio	ALC655 AC'97 Codec, Line-in/out, Mic-in
IDE Interface	1 x IDE (Ultra ATA 33), support 2 IDE devices
SATA	1 x Serial ATA 300MB/s HDD transfer rate
Serial Port	2 x COM port (1 x RS232, 1x RS232/422/485 selectable)
Parallel Port/ Floppy	1 x SPP/EPP/ECP mode 1 x Floppy connector, shared with Parallel Port
KBMS	Standard PS/2 Keyboard and Mouse
Universal Serial Bus	6 x USB 2.0 compliant
LCD	Dual Channel LVDS
Expansion Interface	1 x CF II socket 1 x MiniPCI socket
Hardware Monitor Chip	Integrated in W83627
Operation Temp.	-20°C ~ 70°C (-4°F ~ 158°F)
Watchdog Timer	255-level Reset
Dimension (L x W)	146 x 102 mm (5.7" x 4")

1.10 Board Dimensions

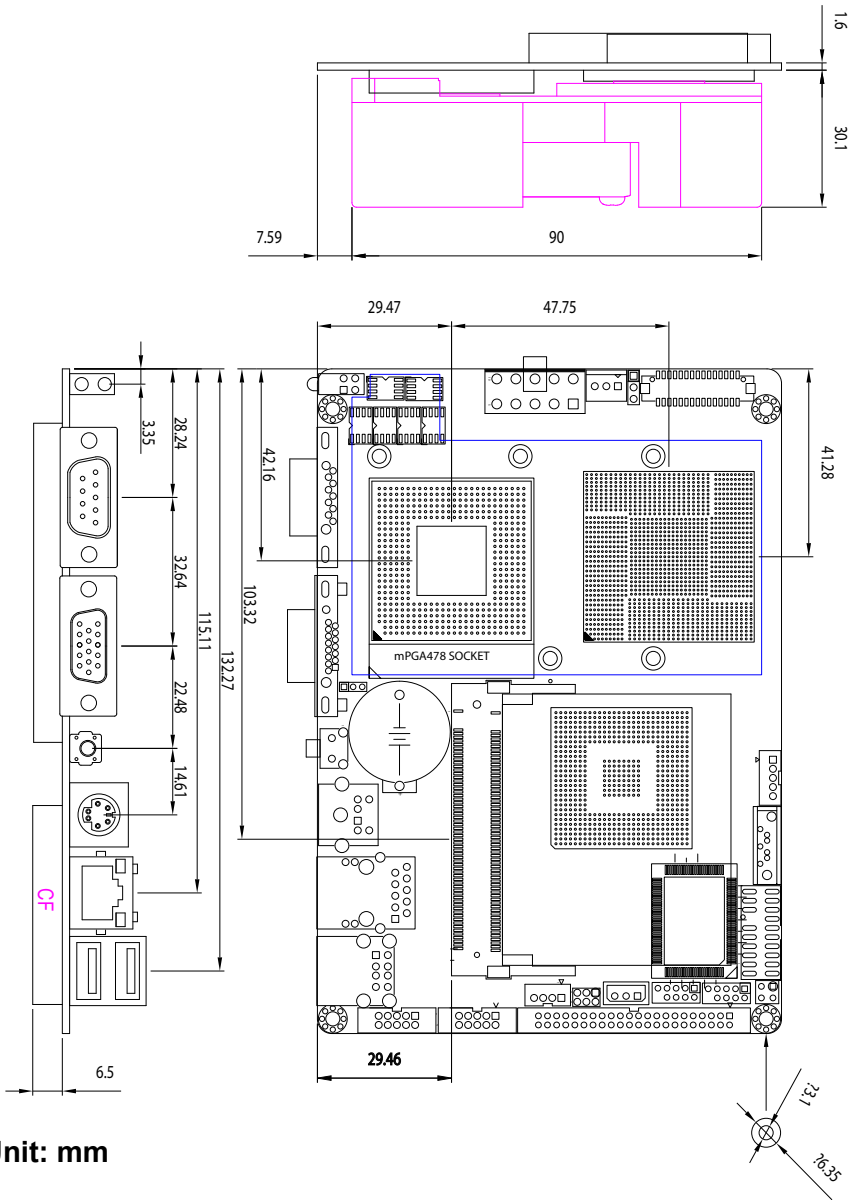

Unit: mm

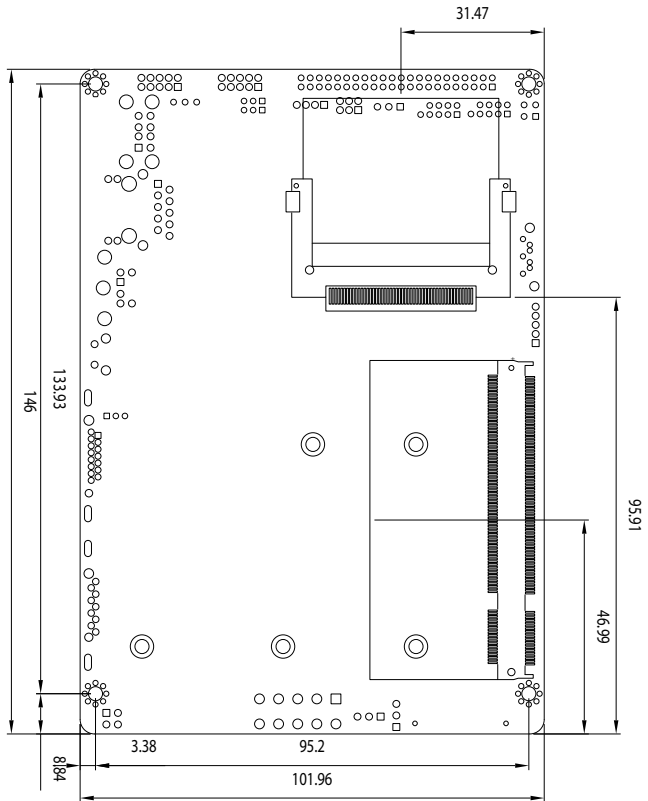

Unit: mm

1.11 Installing the CPU

The processor socket comes with a screw to secure the CPU. As showing in the picture as bellow, loose the screw first before inserting the CPU.

Place the CPU into the socket by making sure the notch on the corner of the CPU corresponding with the notch on the inside of the socket. Once the CPU has slide into the socket, lock the screw.

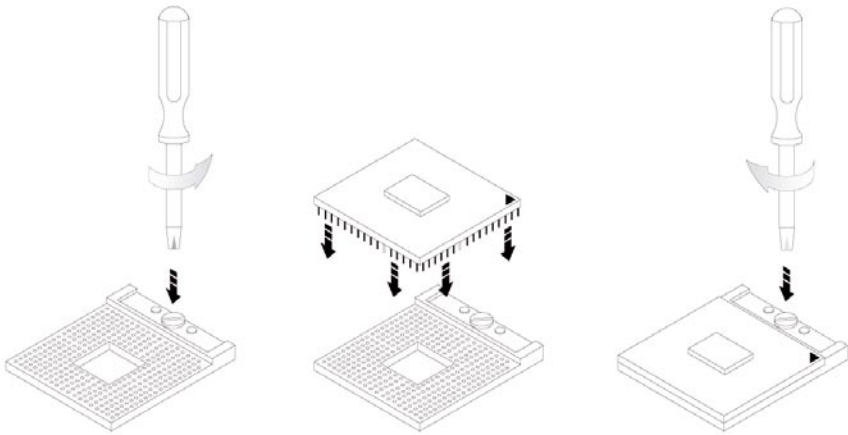

Make sure that heat sink of the CPU top surface is in complete contact to avoid the CPU overheating problem.

If not, it would cause your system or CPU to be hanged, unstable, damaged.

1.12 Installing the Memory

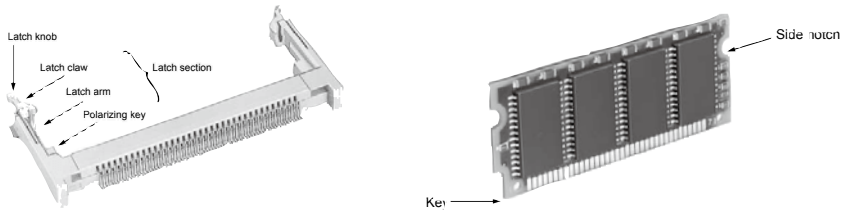

To install the Memory module, locate the Memory SO-DIMM slot on the board and perform as below:

1. Adjust the socket polarizing key and the board key to the same direction.
2. Insert the board obliquely. Moreover, lay the board in parallel to the opening at angle of 20° to 30° , and softly insert the board so as to hit the socket bottom. Stopping insertion halfway will result in improper insertion.
3. Applying the board side notch in parallel to the socket bottom so that the board position cannot be displaced, press the board side notch up, and fix it to the latch portion at both socket edges. Press the board side notch, and release the notch with a snap “click” tone, if the printed board exceeds the latch claw head.

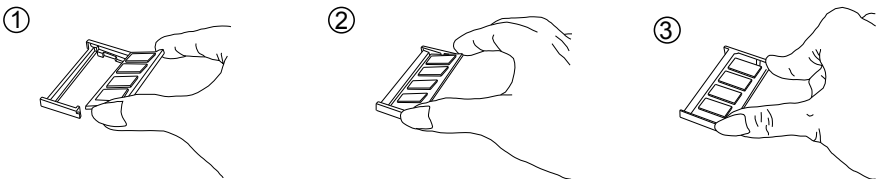

Procedures for board extraction

Apply the thumb nail to the latch knob at both socket edges. Forcibly widen the latch knobs to right and left ways, and release the latch. Then draw the board out along an angle where the board is raised.

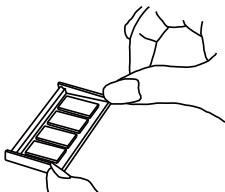

1.13 Heatsink Installation

1. Put the heatsink on EmCORE-i9457, and screw it on in the direction of the board. Insert four screws (No. 1) downward into the holes and turn them tightly.
2. Verify the direction is correct (No. 2) and plug the FAN connector into CPUF1 connector.

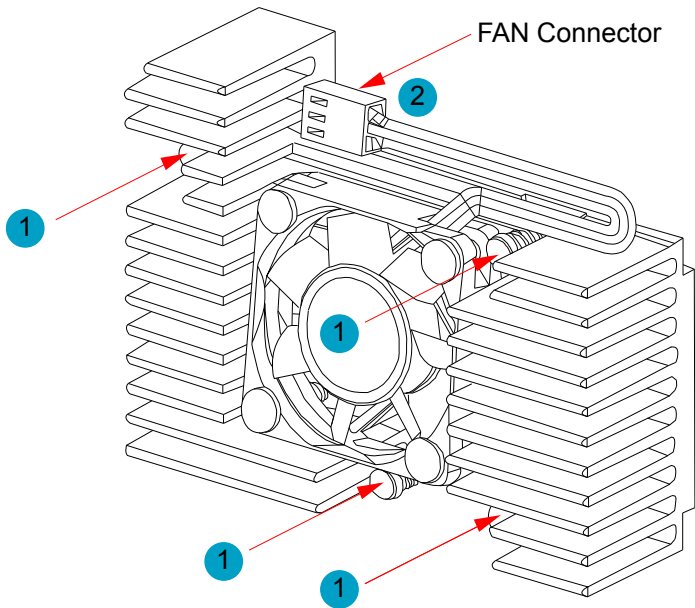

1.14 Heatsink Dimensions

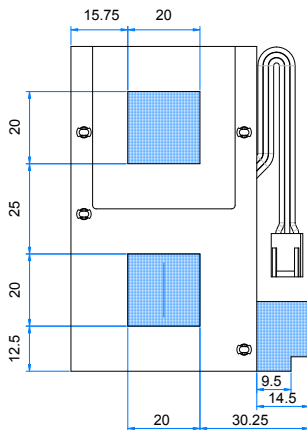
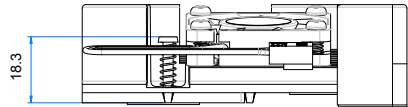
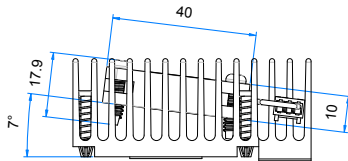
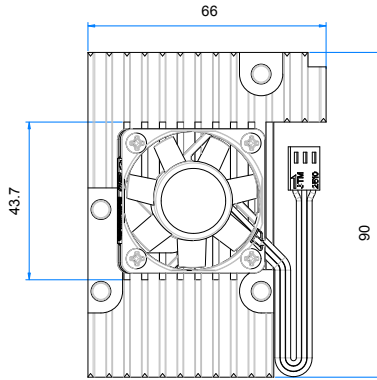



Chapter 2

Installation

2.1 Block Diagrams

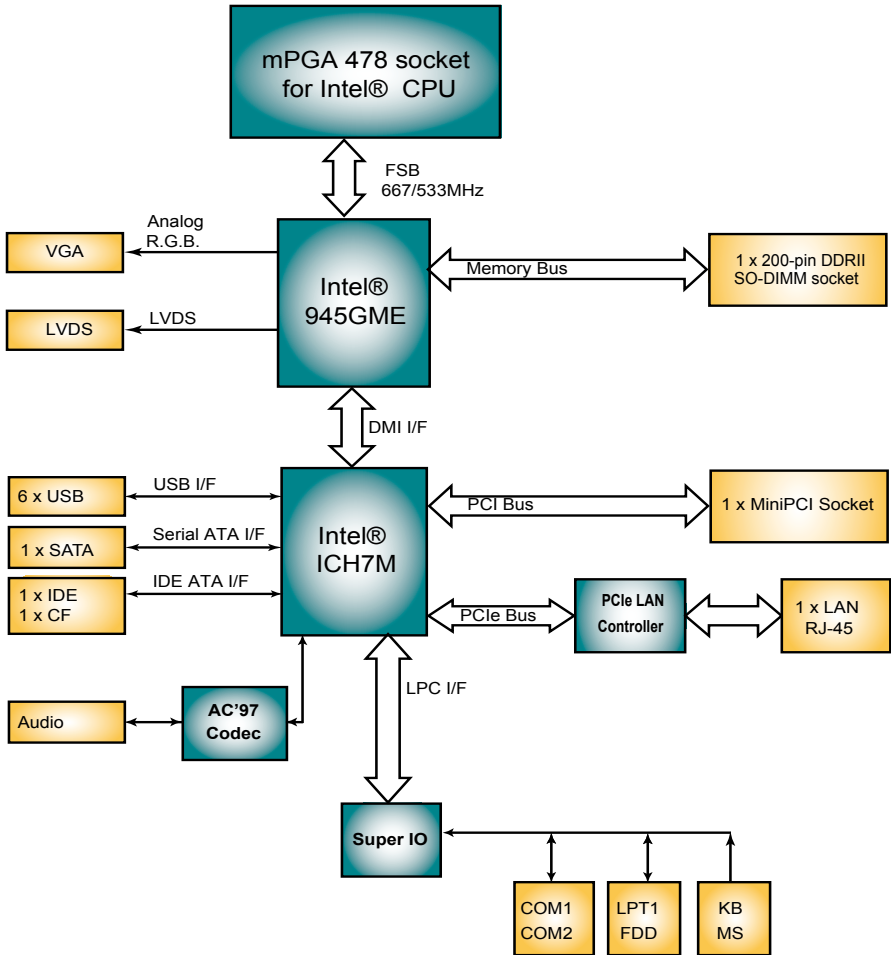

2.2 Jumpers and Connectors

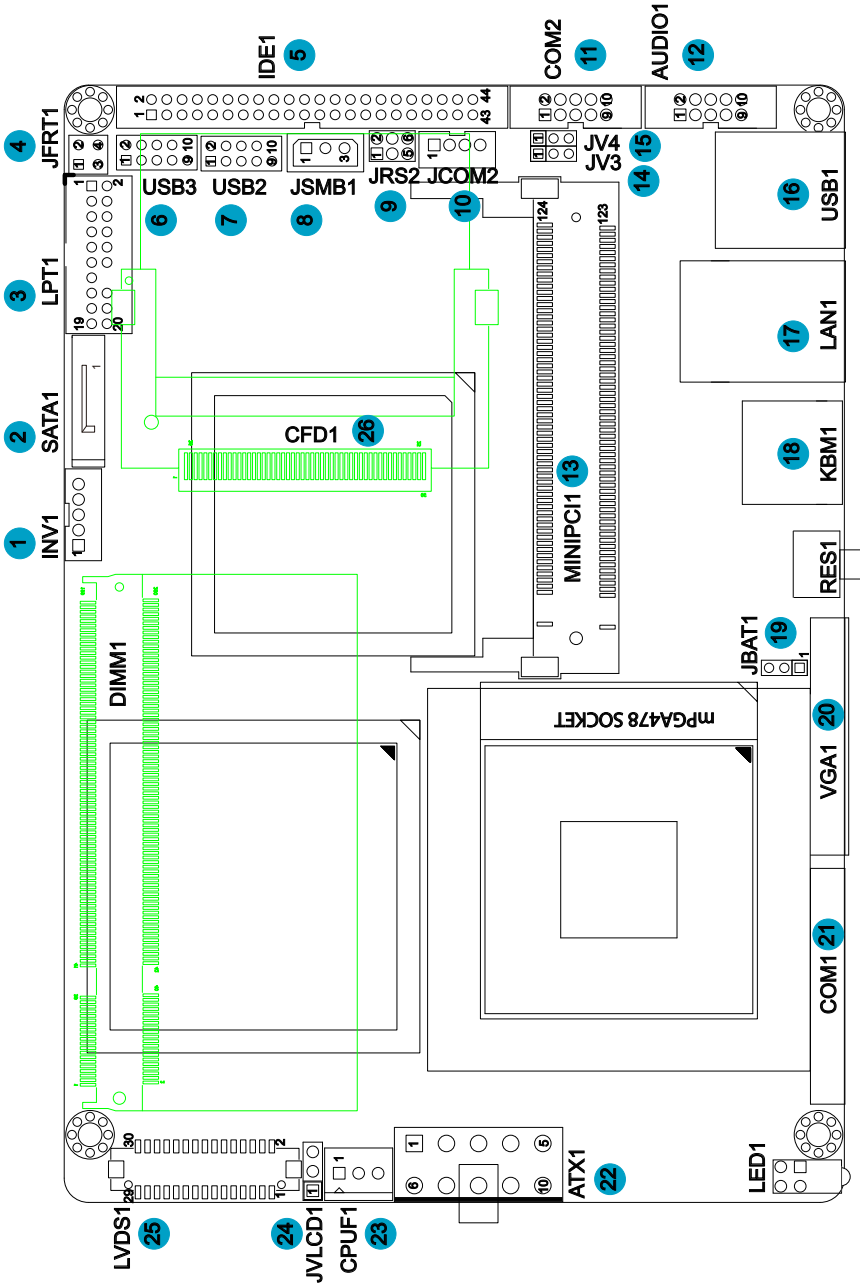

Jumpers

JRS2: COM2 RS-232/422/485 Mode Select (9)

The onboard COM2 port can be configured to operate in RS-422 or RS-485 modes. RS-422 modes differ in the way RX/TX is being handled. Jumper JRS1 switches between RS-232 or RS-422/485 mode. When JRS1 is set to RS-422 or RS-485 mode, there will be only +12V output let while JRS1 is set. All RS-232/422/482 modes are available on COM2.

It can be configured COM2 to operate in RS-232, RS-422 or RS-485 mode
Connector type: 2.00mm pitch 2x3 pin header.

Mode	RS-232 (Default)	RS-422	RS-485
1-2	ON	OFF	OFF
3-4	OFF	ON	OFF
5-6	OFF	OFF	ON



LV3, LV4: COM2 Power source Special Support (14), (15)



The voltage of COM2 could be selected by LV3 and LV4 to +5V or +12V.
Connector type: 2.54mm pitch 1x3 pin header.

Setup	JV3/JV4
POS: +5V on pin 1	
POS: +12V on pin 9	
POS: +5V on pin 1 and +12V on pin 9	

JBAT1: Clear CMOS Setup (19)

If the board refuses to boot due to inappropriate CMOS settings here is how to proceed to clear (reset) the CMOS to its default values.

Connector type: 2.00 mm pitch 1x3 pin header

Pin	Mode	
1-2	Keep CMOS (Default)	
2-3	Clear CMOS	

You may need to clear the CMOS if your system cannot boot up because you forgot your password, the CPU clock setup is incorrect, or the CMOS settings need to be reset to default values after the system BIOS has been updated.

Refer to the following solutions to reset your CMOS setting:

Solution A:

1. Power off the system and disconnect the power cable.
2. Place a shunt to short pin 1 and pin 2 of JBAT1 for five seconds.
3. Place the shunt back to pin 2 and pin 3 of JBAT1.
4. Power on the system.

Solution B:

If the CPU Clock setup is incorrect, you may not be able to boot up. In this case, follow these instructions:

1. Turn the system off, then on again. The CPU will automatically boot up using standard parameters.
2. As the system boots, enter BIOS and set up the CPU clock.



Note:

If you are unable to enter BIOS setup, turn the system on and off a few times.

JVLCD1: LCD Panel Voltage Select (25)

The voltage of LCD panel could be selected by JVLCD1 in +5V or +3.3V.

Connector type: 2.54 mm pitch 1x3 pin header

Pin	Voltage	
1-2	+5V	
2-3	+3.3V (Default)	

Connectors

INV1: LCD Inverter Connector (1)

Connector type: 2.00mm pitch 1x5-pin box wafer connector.

Pin	Description
1	+12V
2	GND
3	Backlight on/off
4	Brightness control
5	GND

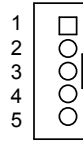

SATA1: Serial ATA Connector (2)

The EmCORE-i9457 CPU board on board supports four SATA II connectors, second generation SATA drives transfer data at speeds as high as 300MB/s, twice the transfer speed of first generation SATA drives. The SATA drives can be configured in a RAID 0, RAID 1 or RAID 10 configuration.

Pin	Description
1	GND
2	TX+
3	TX-
4	GND
5	RX-
6	RX+
7	GND

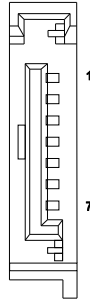

LPT1: Parallel Port or FDD Connector (3)

LPT1 is shared with FDD1. Connector type: 2.00mm pitch 2x10 pin header.

Pin	Description	Pin	Description
1	STROBE	2	AFD
3	PTD0	4	ERROR
5	PTD1	6	INIT
7	PTD2	8	SLIN
9	PTD3	10	GND
11	PTD4	12	GND
13	PTD5	14	N/C (Key)
15	PTD6	16	BUSY
17	PTD7	18	PE
19	ACK	20	SELECT

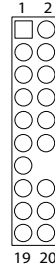

LPT1 can be configured as a connector floppy disk drive interface through BIOS setup.

Pin	Description	Pin	Description
1	N/C	2	RWC-
3	RINDEX-	4	HEAD-
5	TRAK0-	6	DIR-
7	WP-	8	STEP-
9	RDATA-	10	GND
11	DSKCHG-	12	GND
13	N/C	14	N/C
15	N/C	16	MOB-
17	N/C	18	WD-
19	DSB-	20	WE-

BIOS Setup

The default is to set LPT1 as FDD connector. To change the value, get into BIOS setup --> Integrated Peripheral --> Super IO Device.

BIOS Option	Setting	Description
External FDD Controller	Enabled	Set as FDD connector
Onboard Parallel Port	Disabled	
External FDD Controller	Disabled	
Onboard Parallel Port	378/IRQ7	Set as Parallel Port

JFRT1: Switches (4)

It provides connectors for system switches to change the computer status.

Connector type: 2.54 mm pitch 2x2 pin header

Pin	Description	Pin	Description
1	PWRBTN+	2	PWRBTN-
3	RST+	4	RST-



PWRBTN: ATX soft power switch, pin 1-2.

This 2-pin connector connects to the case-mounted Power button.

RES: Reset Button, pin 3-4.

This 2-pin connector connects to the case-mounted reset switch and is used to reboot the system.

IDE1: Primary IDE Connector (5)

An IDE drive ribbon cable has two connectors to support two IDE devices. If a ribbon cable connects to two IDE drives at the same time, one of them has to be configured as Master and the other has to be configured as Slave by setting the drive select jumpers on the drive.

Consult the documentation that came with your IDE drive for details on jumper locations and settings. You must orient the cable connector so that the pin 1 (color) edge of the cable corresponds to pin 1 of the IDE connector.

Connector type: 2.0mm pitch 2x22 box header

Pin	Description	Pin	Description
1	IDE RESET	2	GND
3	DATA7	4	DATA8
5	DATA6	6	DATA9
7	DATA5	8	DATA10
9	DATA4	10	DATA11
11	DATA3	12	DATA12
13	DATA2	14	DATA13
15	DATA1	16	DATA14
17	DATA0	18	DATA15
19	GND	20	N/C (Key)
21	REQ	22	GND
23	IO WRITE	24	GND
25	IO READ	26	GND
27	IO READY	28	IDESEL
29	DACK	30	GND
31	IRQ14	32	N/C
33	ADDR1	34	ATA66 DETECT
35	ADDR0	36	ADDR2
37	CS#2	38	CS#3
39	IDEACTP	40	GND
41	VCC (+5V)	42	VCC (+5V)
43	GND	44	N/C

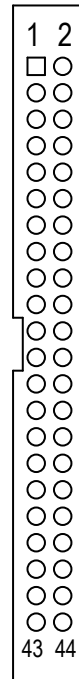

USB2/ USB3: USB Connectors (6), (7)

The EmCORE-i9457 Embedded Board on board supports two headers USB2, USB3 that can connect up to four high-speed (Data transfers at 480MB/s), full-speed (Data transfers at 12MB/s) or low-speed (Data transfers at 1.5MB/s) USB devices.

Connector type: 2.00mm 2x5 pin header

Pin	Description	Pin	Description
1	+5V	2	+5V
3	USBD1-	4	USBD2-
5	USBD1+	6	USBD2+
7	GND	8	GND
9	GND	10	N/C (Key)

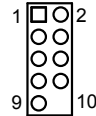

JSMB1: External SMBUS Connector (8)

Connector type: 2.00mm pitch 1x3 box wafer connector.

Pin	Description
1	Data
2	Clock
3	GND



JCOM2: RS-422/ 485 Output Connector (10)

Connector type: 2.00mm pitch 1x4 box wafer connector

Pin	RS-422	RS-485
1	TX+	Data+
2	TX-	Data-
3	RX+	N/C
4	RX-	N/C



COM2: RS-232 Connector (11)

Connector type: 2.00 mm pitch 2x5 box header.

Pin	Description	Pin	Description
1	DCD#	2	RXD
3	TXD	4	DTR#
5	GND	6	DSR#
7	RTS#	8	CTS#
9	RI#	10	N/C

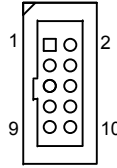

AUDIO1: Front Panel AUDIO Connector (12)

Connect a tape player or another audio source to the light blue Line-in connector to record audio on your computer or to play audio through your computer's sound chip and speakers.

Connect a micro-phone to the pink microphone connector to record audio to your computer.

Connector type: 2.00mm pitch 2x5 pin header.

Pin	Description	Pin	Description
1	Line-in Left	2	Line-in Right
3	GND	4	GND
5	MIC1	6	MIC2
7	GND	8	GND
9	Line-out Left	10	Line-out Right



MINIPCI1: MiniPCI slot (13)



USB1: USB Connector (16)

USB1 supports two USB 2.0 connectors w/ 480MB/s.

Connector type: double stack USB type A.

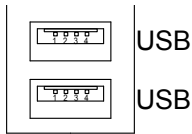

LAN1: RJ-45 Connector (17)

LAN1 supports one 10/100/1000 base-T Ethernet.

Connector type: RJ-45.

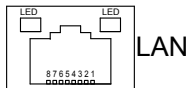

KBM1: Keyboard & Mouse (18)

Mini-Din Keyboard & Mouse connector

Pin	Description
1	KB Data
2	MS Data
3	GND
4	+5V
5	KB Clock
6	MS Clock

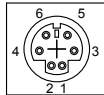

Note: KBM1 supports PS/2 keyboard directly, and PS/2 mouse supported with the additional PS/2 1-to-2 cable in standard packing.

VGA1: CRT Connector (20)

Connector type: D-Sub 15-pin female.

Pin	Description	Pin	Description
1	RED	9	+5V (VCC)
2	GREEN	10	GND
3	BLUE	11	N/C
4	N/C	12	D-DATA
5	GND	13	HSYNC
6	GND	14	VSYNC
7	GND	15	D-DCLK
8	GND		

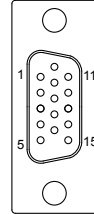

COM1: RS232 Connector (21)

Connector type: D-Sub 9-pin male.

Pin	Description	Pin	Description
1	DCD#	6	DSR#
2	RXD	7	RTS#
3	TXD	8	CTS#
4	DTR#	9	RI#
5	GND		

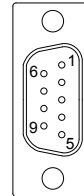

ATX1: ATX Power Supply Connector (23)

The ATX power supply has a single lead connector with a clip on one side of the plastic housing. There is only one way to plug the lead into the ATX power connector. Press the lead connector down until the clip snaps into place and secures the lead onto the connector.

Pin	Description	Pin	Description
6	5VSB	1	PS-ON
7	+5V	2	GND
8	+5V	3	GND
9	N/C	4	+12V
10	GND	5	+3.3V

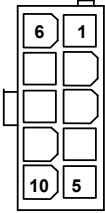

Warning

Incorrect installation of the power supply could result in serious damage to the mainboard and connected peripherals. Make sure the power supply is unplugged from the AC outlet before connecting the leads from the power supply.

CPUF1: CPU Fan Power Connector (24)

CPUF1 is 3-pin header for the system fan. The fan must be a +12V fan.

Pin	Description
1	GND
2	+12V
3	FAN_Detect



LVDS1: LVDS LCD Connector (26)

The LVDS connector supports dual channel LVDS.
 VDD could be selected by JVLCD1 in +5V or +3.3V.
 Connector type: DF-13-30DP-1.25V

Pin	Description	Pin	Description
2	VDD	1	VDD
4	TX2CLK+	3	TX1CLK+
6	TX2CLK-	5	TX1CLK-
8	GND	7	GND
10	TX2D0+	9	TX1D0+
12	TX2D0-	11	TX1D0-
14	GND	13	GND
16	TX2D1+	15	TX1D1+
18	TX2D1-	17	TX1D1-
20	GND	19	GND
22	TX2D2+	21	TX1D2+
24	TX2D2-	23	TX1D2-
26	GND	25	GND
28	TX2D3+	27	TX1D3+
30	TX2D3-	29	TX1D3-

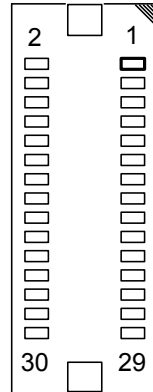

CFD1: Compact Flash II Socket (27)

Connector type: 50-pin compact flash connector

Pin	Description	Pin	Description
1	GND	26	N/C
2	PDD3	27	PDD11
3	PDD4	28	PDD12
4	PDD5	29	PDD13
5	PDD6	30	PDD14
6	PDD7	31	PDD15
7	PDCS1#	32	PDCS3#
8	GND	33	N/C
9	GND	34	PDIOR#
10	GND	35	PDIOW#
11	GND	36	+5V
12	GND	37	PIDEIRQ
13	+5V	38	+5V
14	GND	39	CSEL#
15	GND	40	N/C
16	GND	41	IDERST#
17	GND	42	PIORDY
18	PDA2	43	PDDREQ
19	PDA1	44	PDDACK#
20	PDA0	45	HD_LED1#
21	PDD0	46	PDIAG#
22	PD1	47	PDD8
23	PD2	48	PDD9
24	N/C	49	PDD10
25	N/C	50	GND

The interface of Compact Flash socket is designated to use IDE1.

Installation instructions

Compact Flash (CF) card is “not hot-swap”. If the CF card is swapped in the condition of system power-on, it will damage the CF card.

1. Make sure the Single Board Computer is powered OFF.
2. Plug the Compact Flash Type II device into its socket. Verify the direction is correct.
3. Power up the system.

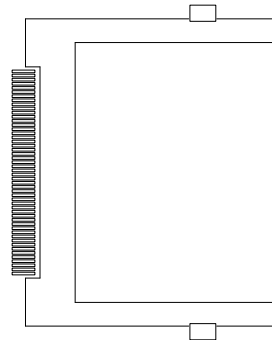

2.3 The Installation Paths of CD Driver

Driver	Path
AUDIO	\AUDIO\REALTEK_AC97\WINDOWS_A401
CHIPSET	\CHIPSET\INTEL\INF 8.1
LAN	\ETHERNET\REALTEK\8111B_WIN5640
VGA	\GRAPHICS\INTEL_2K_XP_32\1431

This page is intentionally left blank.



Chapter 3

BIOS

3.1 BIOS Introduction

The Award BIOS (Basic Input/Output System) installed in your computer system's. The BIOS provides for a standard device such as disk drives, serial ports and parallel ports. It also adds password protection as well as special support for detailed fine-tuning of the chipset controlling the entire system.

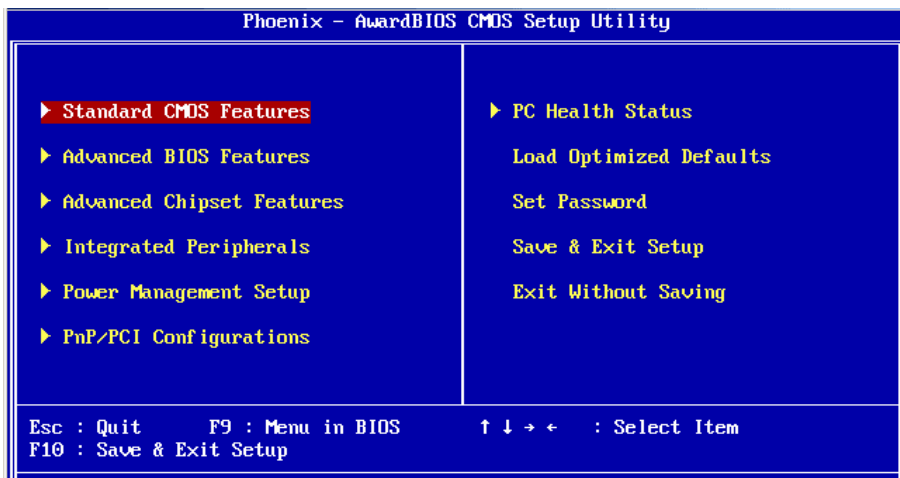

3.2 BIOS Setup

The Award BIOS provides a Setup utility program for specifying the system configurations and settings. The BIOS ROM of the system stores the Setup utility.

When you turn on the computer, the Award BIOS is immediately activated. Pressing the key immediately allows you to enter the Setup utility. If you a little bit late press the key, POST (Power On Self Test) will continue with its test routines, thus preventing you from invoking the Setup. If you still wish to enter Setup, restart the system by pressing the "Reset" button or simultaneously pressing the <Ctrl>, <Alt> and <Delete> keys. You can also restart by turning the system Off and back On again.

The following message will appear on the screen:

Press to Enter Setup

In general, you press the arrow keys to highlight items, <Enter> to select, the <PgUp> and <PgDn> keys to change entries, <F1> for help and <Esc> to quit. When you enter the Setup utility, the Main Menu screen will appear on the screen. The Main Menu allows you to select from various setup functions and exit choices.

3.3 Standard CMOS Features

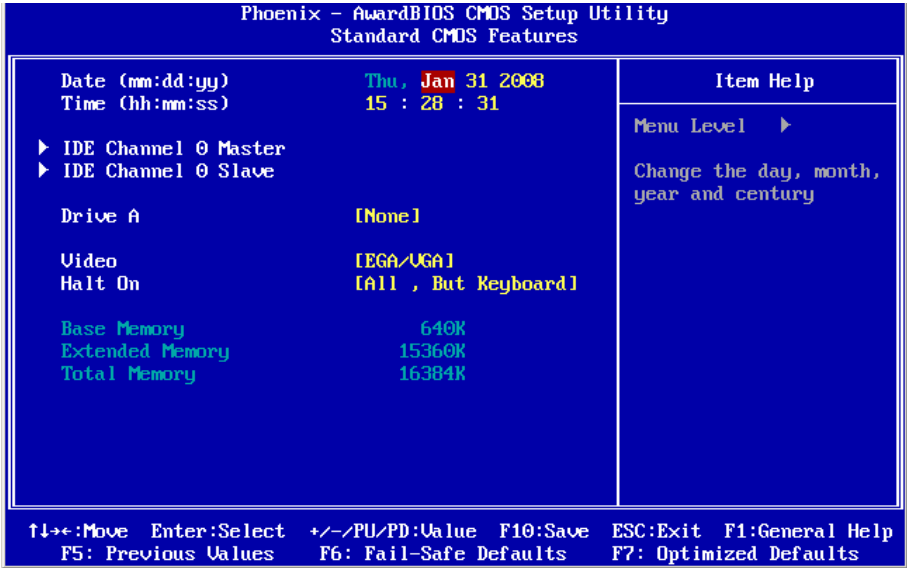

“Standard CMOS Features” allows you to record some basic hardware configurations in your computer system and set the system clock and error handling. If the CPU card is already installed in a working system, you will not need to select this option.

You will need to run the Standard CMOS option, however, if you change your system hardware configurations, such as onboard battery fails, or the configuration stored in the CMOS memory was lost or damaged.

Date

The date format is:

- Day** : Sun to Sat
- Month** : 1 to 12
- Date** : 1 to 31
- Year** : 1999 to 2099

Time

The time format is:

- Hour** : 00 to 23
- Minute** : 00 to 59
- Second** : 00 to 59

To set the date & time, highlight the “Date” & “Time” and use the <PgUp>/<PgDn> or +/- keys to set the current time.

IDE Channel 0 Master/ Slave

The onboard PCI IDE connectors provide Primary and Secondary channels for connecting up to four IDE hard disks or other IDE devices.

Each channel can support up to two hard disks; the first is the “Master” and the second is the “Slave”.

Press <Enter> to configure the hard disk. The selections include Auto, Manual, and None. Select ‘Manual’ to define the drive information manually.

You will be asked to enter the following items.

Cylinder:	Number of cylinders
Head:	Number of read/write heads
Precomp:	Write precompensation
Landing Zone:	Landing zone
Sector:	Number of sectors

The Access Mode selections are as follows:

CHS	(HD < 528MB)
LBA	(HD > 528MB and supports Logical Block Addressing)
Large	(for MS-DOS only)
Auto	

Drive A

These fields identify the types of floppy disk drive A that has been installed in the computer. The available specifications are:

None	360K, 5.25 in.	1.2M, 5.25 in.
720K, 3.5 in.	1.44M, 3.5 in.	2.88M, 3.5 in.

Video

This field selects the type of video display card installed in your system.

You can choose the following video display cards:

EGA/VGA	For EGA, VGA, SEGA, SVGA or PGA monitor adapters. (default)
CGA 40	Power up in 40 column mode.
CGA 80	Power up in 80 column mode.
MONO	For Hercules or MDA adapters.

Halt On

This field determines whether or not the system will halt if an error is detected during power up.

All errors	Whenever the BIOS detects a non-fatal error, the system will stop and you will be prompted.
No errors (default)	The system boot will not be halted for any error that may be detected.
All, But Keyboard	The system boot will not be halted for a keyboard error; it will stop for all other errors.
All, But Diskette	The system boot will not be halted for a disk error; it will stop for all other errors.
All, But Disk/Key	The system boot will not be halted for a keyboard or disk error; it will stop for all others.

3.4 Advance BIOS Features

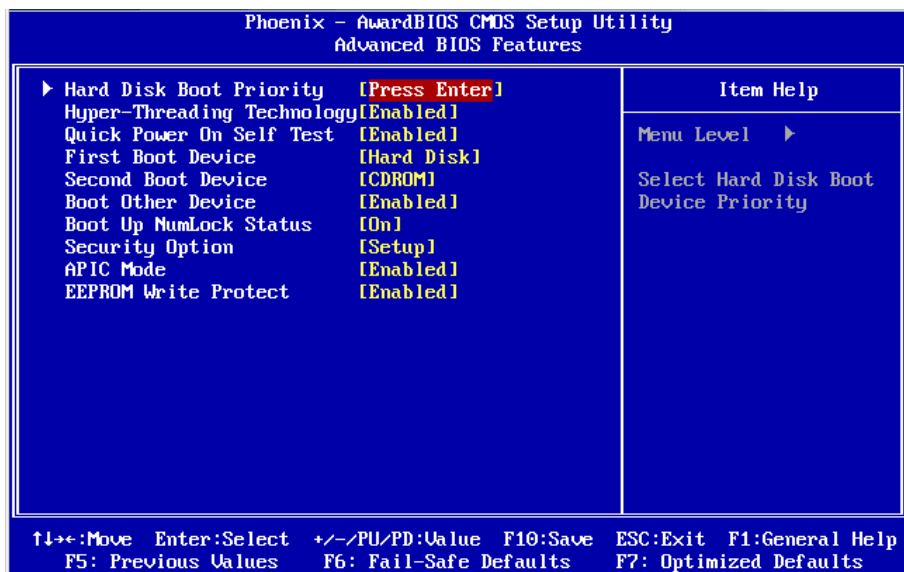

Hard Disk Boot Priority

It allows you to set the priority for hard disk boot. When you press enter, the selections shows the current hard disks used in your system as well as the “Bootable Add-in Card” that is relevant to other boot sources media such as SCSI cards and LAN cards.

Hyper-Threading Technology

If enabled, when your processor supports Hyper-Threading Technology.

Quick Power On Self Test

When enabled, it speeds up the Power On Self Test (POST) after the system is turned on.

If it is set to Enabled, BIOS will skip some items.

Setting: Disabled, Enabled (Default).

First/ Second Boot Device

These fields determine the drive that the system searches first for an operating system. The options available include Floppy, Hard Disk, CDROM, USB-FDD, USB-ZIP, USB-CDROM, LAN and Disabled.

Boot Other Device

It allows the system to search for an OS from other devices other than the ones selected in the First/ Second/ Third Boot Device.
Setting: Disabled, Enabled (Default).

Boot Up NumLock Status

It allows you to activate the NumLock function after you power up the system.
Setting: Off, On (Default).

Security Option

It allows you to limit access to the System and Setup.

When you select System, the system prompts for the User Password every time you boot up.

When you select Setup, the system always boots up and prompts for the Supervisor Password only when the Setup utility is called up.

Setting: Setup (Default), System.

APIC Mode

APIC stands for Advanced Programmable Interrupt Controller.

Setting: Disabled, Enabled (Default).

EEPROM Write Protect

Setting: Disabled, Enabled (Default).

3.5 Advanced Chipset Features

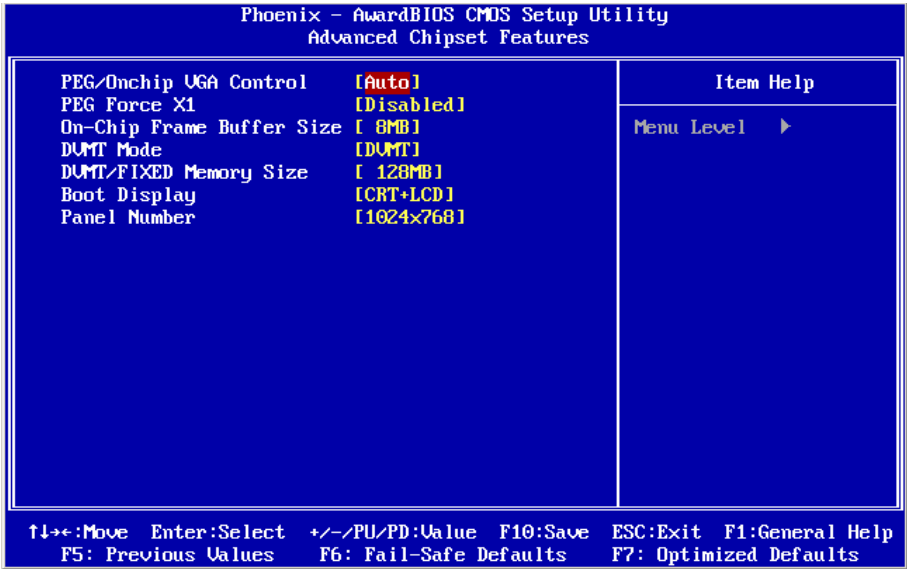

PEG/Onchip VGA Control

Setting: Onchip VGA, PEG Port, Auto (Default).

PEG Force X1

Setting: Disabled (Default), Enabled.

On-Chip Frame Buffer Size

Setting: 1MB, 8MB (Default).

DVMT Mode

Setting: FIXED, DVMT (Default), Both.

DVMT/FIXED Memory Size

Setting: 64MB, 128MB (Default), 224MB.

Boot Display

Setting: CRT, LCD, CRT+LCD (Default).

Panel Number

It allows you to select the LCD Panel type as below ---

Setting: 640x480
 800x600
 1024x768 (Default)
 1280x768
 1400x1050
 1400x1050
 1600x1200
 1280x768
 1680x1050
 1920x1200

3.6 Integrated Peripherals

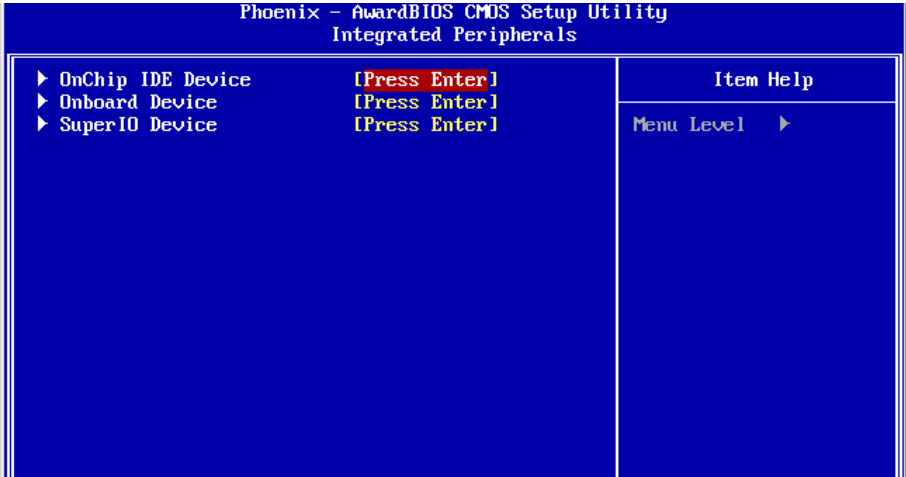

OnChip IDE Device >>>

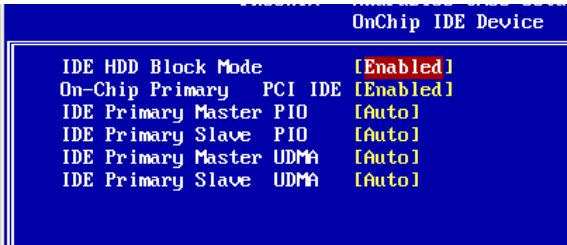

IDE HDD Block Mode

It allows HDD controller to use the fast block mode to transfer data to and from HDD.

Setting: Disabled, Enabled (Default).

On-Chip Primary PCI IDE

The integrated peripheral controller contains an IDE interface with support for two IDE channels. Select Enabled to activate each channel separately.

Setting: Disabled, Enabled (Default).

IDE Primary Master/Slave PIO

It allows your system HDD controller to run faster.

Rather than having the BIOS issue with a series of commands that transferring to or from the disk drive, PIO (Programmed Input/Output) allows the BIOS to communicate with the controller and CPU directly.

When Auto is selected, the BIOS will select the best available mode.

Setting: Auto (Default), Mode 0, Mode 1, Mode 2, Mode 3, Mode 4.

IDE Primary Master/Slave UDMA

It allows your system to improve disk I/O throughput to 33MB/sec with the Ultra DMA33 feature.

Setting: Disabled, Auto.

Onboard Device >>>

Onboard Device	
USB Controller	[Enabled]
USB 2.0 Controller	[Enabled]
USB Keyboard Support	[Disabled]
AC97 Audio	[Auto]

USB Controller

Setting: Enabled (Default), Disabled.

USB 2.0 Controller

For using USB 2.0, it is necessary OS drivers must be installed first. Please update your system to at least Windows 2000 SP4 or Windows XP SP2.

Setting: Enabled (Default), Disabled.

USB Keyboard Support

Setting: Disabled, Enabled (Default).

AC97 Audio

Setting: Auto (Default), Disabled.

SuperIO Device >>>

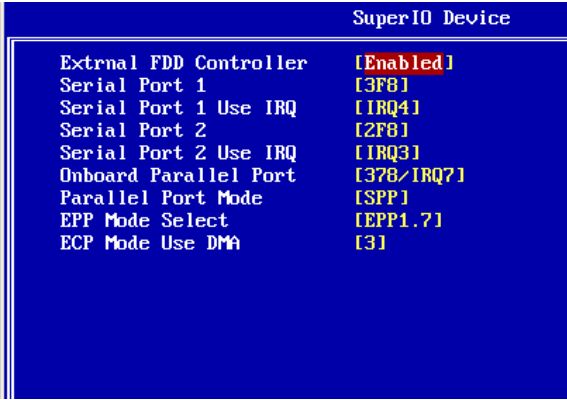

Onboard FDC Controller

Select “Enabled” if your system has a floppy disk controller (FDC) installed and you wish to use it. Select “Disabled” if your system has an add-in FDC or has no floppy drive.

Setting: Disabled, Enabled (Default).

Onboard Serial/Parallel Port

It allows you to select the onboard serial and parallel ports with their addresses.

Setting:	Serial Port 1	3F8/IRQ4	(Default)
	Serial Port 2	2F8/IRQ3	(Default)
	Parallel Port	378/IRQ7	(Default)

Parallel Port Mode

Setting: SPP (Default)
EPP
ECP
ECP+EPP
Normal

EPP Mode Select

Setting: EPP1.9, EPP1.7 (Default)

ECP Mode Use DMA

Setting: 1, 3 (Default).

3.7 Power Management Setup

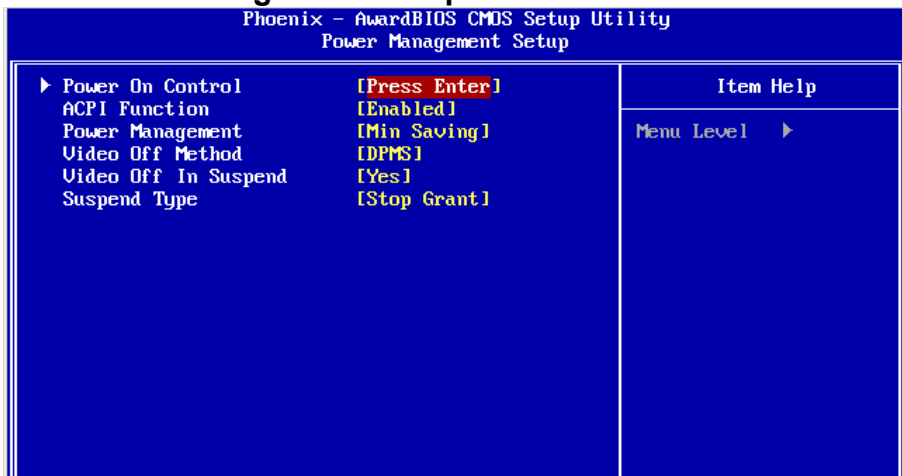

ACPI Function

It supports ACPI (Advance Configuration and Power Interface).

Setting: Enabled (Default), Disabled.

Power Management

It allows you to select the type of power saving management modes.

Setting: User Define (Default) Each of the ranges is from 1 min. to 1hr.
Except for HDD Power Down which ranges from 1 min. to 15 min

Min Saving	Minimum power management
Max Saving	Maximum power management

Video Off Method

It defines the Video Off features.

Setting: Blank Screen	Writes blanks to the video buffer
V/H SYNC + Blank	blank the screen and turn off vertical and horizontal scanning
DPMS (Default)	Allowing BIOS to control the video display.

Video Off In Suspend

When enabled, the video is off in suspend mode.

Setting: No, Yes (Default).

Suspend Type

Setting: Stop Grant (Default), PwrOn Suspend.

Power On Control>>>

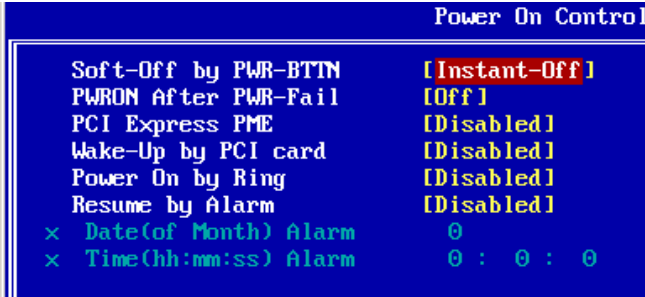

Soft-Off by PWR-BTTN

It defines the power-off mode when using an ATX power supply. In the Instant Off mode, It allows powering off immediately upon pressing the power button.

In the Delay 4 Sec mode, the system powers off when the power button is pressed for more than 4 seconds or enters the suspend mode when pressed for less than 4 seconds.

Setting: Instant-off (Default), Delay 4 Sec. .

PWRON After PWR-Fail

It sets the system power status whether on or off when power returns to the system from a power failure situation.

Setting: Off (Default), On, Former-Sts.

Wake-Up by PCI Card

It allows the system to wake up from a signal received from a PCI card such as a LAN card.

Setting: Disabled (Default), Enabled.

Power On by Ring

It enables or disables the power on of the system through the modem connected or LAN.

Setting: Disabled (Default), Enabled.

Resume by Alarm

It enables or disables the resumption of the system operation. When enabled, the user is allowed to set the Date and Time.

Setting: Disabled (Default), Enabled.

3.8 PNP/PCI Configurations

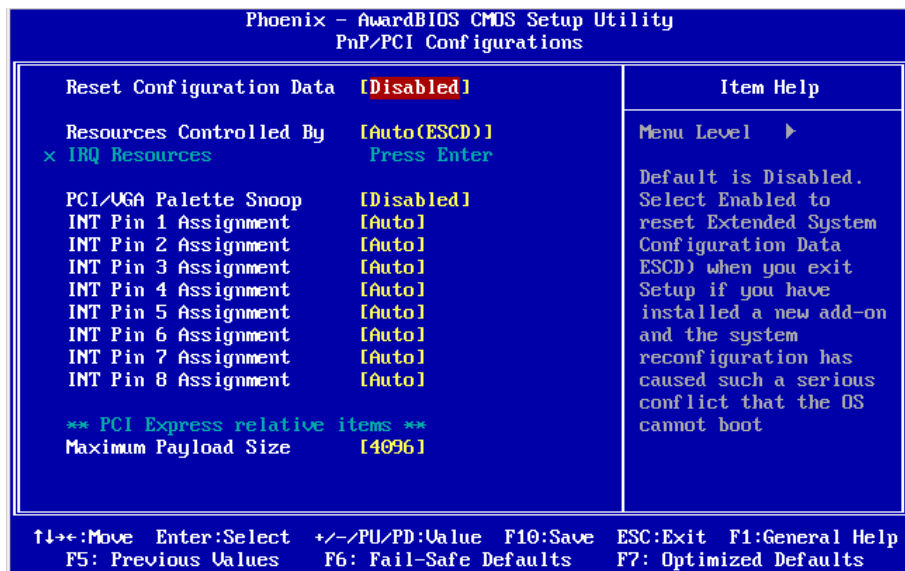

Reset Configuration Data

It allows you to determine whether to reset the configuration data or not.
Setting: Disabled (Default), Enabled.

Resources Controlled By

This PnP BIOS can configure all of the boot and compatible devices with the use of a PnP operating system.
Setting: Auto(ESCD) (Default), Manual.

IRQ Resources

It allows you to configure the IRQ Resources.

PCI/VGA Palette Snoop

Some non-standard VGA display cards may not show colors properly. It allows you to set whether or not MPEG ISA/VESA VGA cards can display with PCI/VGA.

When “Enabled”, a PCI/VGA can display with an MPEG ISA/VESA VGA card.

When “Disabled”, a PCI/VGA cannot display with an MPEG ISA/VESA VGA card.

Setting: Disabled (Default), Enabled.

INT Pin 1-8 Assignment

Setting: Auto (Default), 3, 4, 5, 7, 9, 10, 11, 12, 14, 15.

Maximum Payload Size

It allows you to set maximum TLP payload size for PCI Express devices. The unit is byte.

Setting: 128, 256, 512, 1024, 2048, 4096 (Default).

3.9 PC Health Status

Phoenix - AwardBIOS CMOS Setup Utility	
PC Health Status	
Current System Temperature	Item Help
Current CPU Temperature	
Current CPU FAN	
CPU VCore	Menu Level ▶
1.5V	
VCC3	
+ 5 V	
+12 V	
VBAT(V)	
5USB(V)	
↑↓←→:Move Enter:Select +/-/PU/PD:Value F10:Save ESC:Exit F1:General Help F5: Previous Values F6: Fail-Safe Defaults F7: Optimized Defaults	

Current System Temperature

Current CPU Temperature

Current System FAN

Current CPU FAN

Vcore

3.10 Load Optimized Defaults

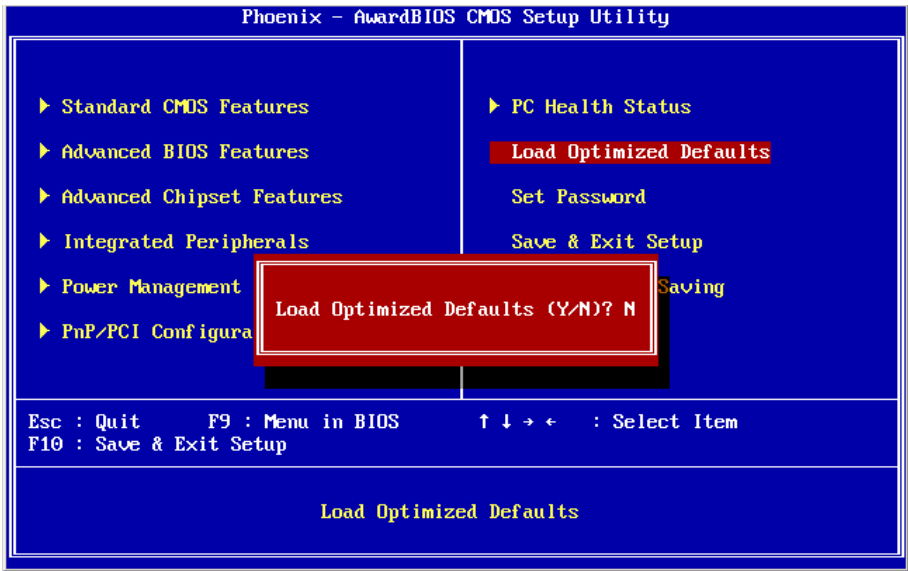

It allows you to load the default values to your system configuration. The default setting is optimal and enabled all high performance features.

3.11 Set Password

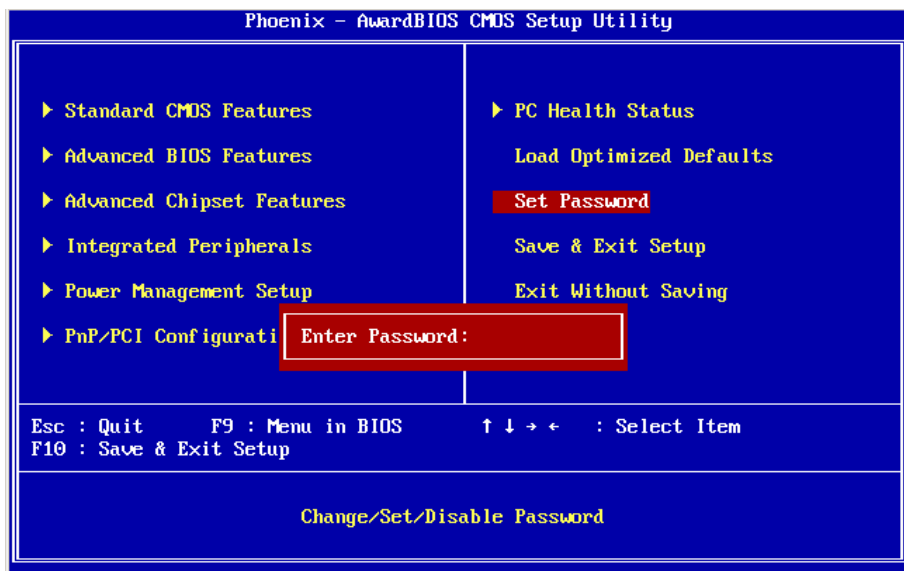

Using Password to set a password that will be used exclusively on the system. To specify a password, highlight the type you want and press <Enter>.

The Enter Password: message prompts on the screen. Type the password, up to eight characters in length, and press <Enter>. And the system confirms your password by asking you to type it again. After setting a password, the screen automatically returns to the main screen.

To disable a password, just press the <Enter> key when you are prompted to enter the password. A message will confirm the password to be disabled. Once the password is disabled, the system will boot, then you can enter BIOS Setup freely.

3.12 Save & Exit Setup

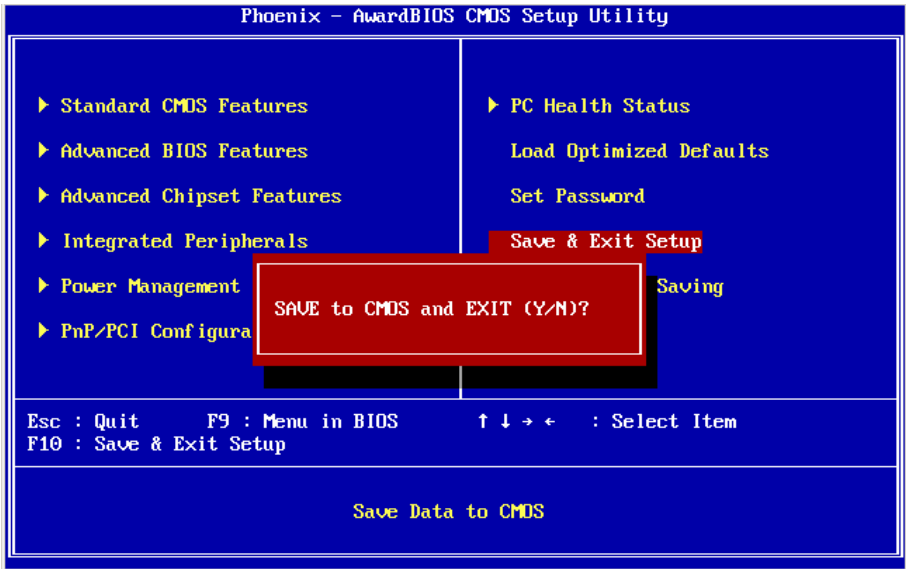

Typing “Y”, you will quit the setup utility and save all the changes into the CMOS memory.

Typing “N”, you will return to Setup utility.

3.13 Exit Without Saving

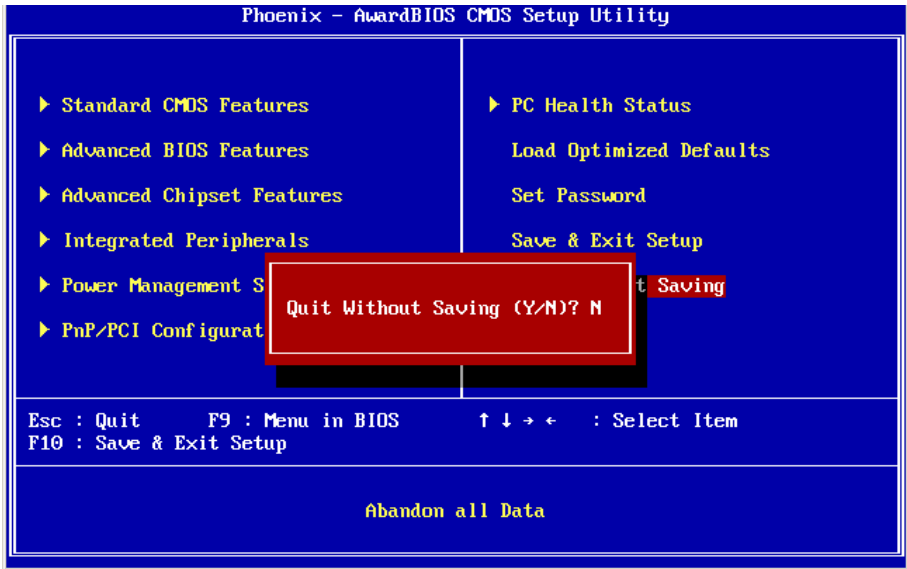

Typing “Y” will quit the Setup utility without saving the modifications. Typing “N” will return you to Setup utility.

3.14 BIOS Beep Sound code list

Beep Sound	Message
1 short (Beep)	System booting is normally
2 short (Beep)	CMOS setting error
1 long - 1 short (Beep)	DRAM error
1 long - 2 short (Beep)	Display card or monitor connected error
1 long - 3 short (Beep)	Keyboard error
1 long - 9 short (Beep)	ROM error
Long (Beep) continuous	DRAM hasn't inset correctly
Short (Beep) continuous	POWER supply has problem

3.15 BIOS memory mapping

Address	Device Description
E000:0000h - F000:FFFFh	System BIOS Area
D000:2000h - D000:FFFFh	Free space
D000:0000h - D000:1FFFh	LAN ROM
C000:E000h - CF00:FFFFh	Free space
C000:0000h - C000:DFFFh	VGA BIOS
A000:0000h - B000:FFFFh	VGA RAM
0000:0000h - 9000:FFFFh	DOS 640K

3.16 Award BIOS Post Codes

CFh	Test CMOS read/write functionality
C0h	Early chipset initialization: Disable shadow RAM, L2 cache (socket 7 and below), program basic chipset registers
C1h	Detect memory: Auto detection of DRAM size, type and ECC, auto detection of L2 cache (socket 7 and below)
C3h	Expand compressed BIOS code to DRAM
C5h	Call chipset hook to copy BIOS back to E000 & F000 shadow RAM
01h	Expand the Xgroup codes located in physical memory address 1000:0
02h	Reserved
03h	Initial Superio_Early_Init switch
04h	Reserved
05h	Blank out screen; Clear CMOS error flag
06h	Reserved
07h	Clear 8042 interface; Initialize 8042 self test
08h	Test special keyboard controller for Winbond 977 series Super I/O chips; Enable keyboard interface
09h	Reserved
0Ah	Disable PS/2 mouse interface (optional); Auto detect ports for keyboard & mouse followed by a port & interface swap (optional); Reset keyboard for Winbond 977 series Super I/O chips
0Bh	Reserved
0Ch	Reserved
0Dh	Reserved
0Eh	Test F000h segment shadow to see whether it is read/write capable or not. If test fails, keep beeping the speaker
0Fh	Reserved
10h	Auto detect flash type to load appropriate flash read/write codes into the run time area in F000 for ESCD & DMI support
11h	Reserved
12h	Use walking 1's algorithm to check out interface in CMOS circuitry. Also set real time clock power status and then check for override
13h	Reserved
14h	Program chipset default values into chipset. Chipset default values are MODBINable by OEM customers
15h	Reserved
16h	Initial Early_Init_Onboard_Generator switch
17h	Reserved
18h	Detect CPU information including brand, SMI type (Cyrix or Intel) and CPU level (586 or 686)
19h	Reserved
1Ah	Reserved
1Bh	Initial interrupts vector table. If no special specified, all H/W interrupts are directed to SPURIOUS_INT_HDLR & S/W interrupts to SPURIOUS_soft_HDLR
1Ch	Reserved
1Dh	Initial EARLY_PM_INIT switch
1Eh	Reserved
1Fh	Load keyboard matrix (notebook platform)

20h	Reserved
21h	HPM initialization (notebook platform)
22h	Reserved
23h	Check validity of RTC value; Load CMOS settings into BIOS stack. If CMOS checksum fails, use default value instead; Prepare BIOS resource map for PCI & PnP use. If ESCD is valid, take into consideration of the ESCD's legacy information; Onboard clock generator initialization. Disable respective clock resource to empty PCI & DIMM slots; Early PCI initialization - Enumerate PCI bus number, assign memory & I/O resource, search for a valid VGA device & VGA BIOS, and put it into C000:0
24h	Reserved
25h	Reserved
26h	Reserved
27h	Initialize INT 09 buffer
28h	Reserved
29h	Program CPU internal MTRR (P6 & PII) for 0-640K memory address; Initialize the APIC for Pentium class CPU; Program early chipset according to CMOS setup; Measure CPU speed; Invoke video BIOS
2Ah	Reserved
2Bh	Reserved
2Ch	Reserved
2Dh	Initialize multilanguage; Put information on screen display, including Award title, CPU type, CPU speed, etc...
2Eh	Reserved
2Fh	Reserved
30h	Reserved
31h	Reserved
32h	Reserved
33h	Reset keyboard except Winbond 977 series Super I/O chips
34h	Reserved
35h	Reserved
36h	Reserved
37h	Reserved
38h	Reserved
39h	Reserved
3Ah	Reserved
3Bh	Reserved
3Ch	Test 8254
3Dh	Reserved
3Eh	Test 8259 interrupt mask bits for channel 1
3Fh	Reserved
40h	Test 9259 interrupt mask bits for channel 2
41h	Reserved
42h	Reserved
43h	Test 8259 functionality
44h	Reserved
45h	Reserved
46h	Reserved

47h	Initialize EISA slot
48h	Reserved
49h	Calculate total memory by testing the last double last word of each 64K page; Program writes allocation for AMD K5 CPU
4Ah	Reserved
4Bh	Reserved
4Ch	Reserved
4Dh	Reserved
4Eh	Program MTRR of M1 CPU; initialize L2 cache for P6 class CPU & program cacheable range; Initialize the APIC for P6 class CPU; On MP platform, adjust the cacheable range to smaller one in case the cacheable ranges between each CPU are not identical
4Fh	reserved
50h	Initialize USB
51h	Reserved
52h	Test all memory (clear all extended memory to 0)
53h	Reserved
54h	Reserved
55h	Display number of processors (multi-processor platform)
56h	Reserved
57h	Display PnP logo; Early ISA PnP initialization and assign CSN to every ISA PnP device
58h	Reserved
59h	Initialize the combined Trend Anti-Virus code
5Ah	Reserved
5Bh	Show message for entering AWDFLASH.EXE from FDD (optional feature)
5Ch	Reserved
5Dh	Initialize Init_Onboard_Super_IO switch; Initialize Init_Onboard_AUDIO switch
5Eh	Reserved
5Fh	Reserved
60h	Okay to enter Setup utility
61h	Reserved
62h	Reserved
63h	Reserved
64h	Reserved
65h	Initialize PS/2 mouse
66h	Reserved
67h	Prepare memory size information for function call: INT 15h ax=E820h
68h	Reserved
69h	Turn on L2 cache
6Ah	Reserved
6Bh	Program chipset registers according to items described in Setup & Auto-Configuration table
6Ch	Reserved
6Dh	Assign resources to all ISA PnP devices; Auto assign ports to onboard COM ports if the corresponding item in Setup is set to "AUTO"
6Eh	Reserved
6Fh	Initialize floppy controller; Setup floppy related fields in 40:hardware

70h	Reserved
71h	Reserved
72h	Reserved
73h	Enter AWDFLASH.EXE if: AWDFLASH.EXE is found in floppy drive and ALT+F2 is pressed
74h	Reserved
75h	Detect and install all IDE devices: HDD, LS120, ZIP, CDROM...
76h	Reserved
77h	Detect serial ports and parallel ports
78h	Reserved
79h	Reserved
7Ah	Detect and install coprocessor
7Bh	Reserved
7Ch	Reserved
7Dh	Reserved
7Eh	Reserved
7Fh	Switch back to text mode if full screen logo is supported: if errors occur, report errors & wait for keys, if no errors occur or F1 key is pressed continue - Clear EPA or customization logo
80h	Reserved
81h	Reserved
82h	Call chipset power management hook: Recover the text font used by EPA logo (not for full screen logo), If password is set, ask for password
83h	Save all data in stack back to CMOS
84h	Initialize ISA PnP boot devices
85h	Final USB initialization; NET PC: Build SYSID structure; Switch screen back to text mode; Set up ACPI table at top of memory; Invoke ISA adapter ROM's; Assign IRQ's to PCI devices; Initialize APM; Clear noise of IRQ's
86h	Reserved
87h	Reserved
88h	Reserved
89h	Reserved
90h	Reserved
91h	Reserved
92h	Reserved
93h	Read HDD boot sector information for Trend Anti-Virus code
94h	Enable L2 cache; Program boot up speed; Chipset final initialization; Power management final initialization; Clear screen and display summary table; Program K6 write allocation; Program P6 class write combining
95h	Program daylight saving; Update keyboard LED and typematic rate
96h	Build MP table; Build and update ESCD; Set CMOS century to 20h or 19h; Load CMOS time into DOS timer tick; Build MSIRQ routing table
FFh	Boot attempt (INT 19h)

This page is intentionally left blank.



Chapter 4

Appendix

4.1 I/O Port Address Map

Each peripheral device in the system is assigned a set of I/O port addresses which also becomes the identity of the device.

The following table lists the I/O port addresses used.

Address	Device Description
00000000 - 00000CF7	PCI bus
00000000 - FFFFFFFF	ISAPNP Read Data Port
00000060 - 00000060	Standard 101/102-Key or Microsoft Natural PS/2 Keyboard
00000064 - 00000064	Standard 101/102-Key or Microsoft Natural PS/2 Keyboard
00000070 - 00000073	System CMOS/real time clock
00000170 - 00000177	Secondary IDE Channel
000001F0 - 000001F7	Primary IDE Channel
00000274 - 00000277	ISAPNP Read Data Port
00000279 - 00000279	ISAPNP Read Data Port
000002F8 - 000002FF	Communications Port
00000378 - 0000037F	Printer Port
000003B0 - 000003BB	Intel(R) 82945G Express Chipset Family
000003C0 - 000003DF	Intel(R) 82945G Express Chipset Family
000003F0 - 000003F5	Standard floppy disk controller
000003F6 - 000003F6	Primary IDE Channel
000003F7 - 000003F7	Standard floppy disk controller
000003F8 - 000003FF	Communications Port
00000778 - 0000077B	Printer Port
00000A79 - 00000A79	ISAPNP Read Data Port
00000D00 - 0000FFFF	PCI bus
0000B000 - 0000BFFF	Intel(R) 82801G (ICH7 Family) PCI Express Root Port - 27D6
0000BE00 - 0000BEFF	Realtek RTL8168/8111 PCI-E Gigabit Ethernet NIC

Appendix

0000C000 - 0000CFFF	Intel(R) 82801G (ICH7 Family) PCI Express Root Port - 27D0
0000F000 - 0000F0FF	Realtek AC'97 Audio
0000F800 - 0000F80F	Intel(R) 82801G (ICH7 Family) Ultra ATA Storage Controllers - 27DF
0000FA00 - 0000FA3F	Realtek AC'97 Audio
0000FB00 - 0000FB1F	Intel(R) 82801G (ICH7 Family) USB Universal Host Controller - 27CB
0000FC00 - 0000FC1F	Intel(R) 82801G (ICH7 Family) USB Universal Host Controller - 27CA
0000FC00 - 0000FC1F	Intel(R) 82801G (ICH7 Family) USB Universal Host Controller - 27C9
0000FE00 - 0000FE1F	Intel(R) 82801G (ICH7 Family) USB Universal Host Controller - 27C8
0000FF00 - 0000FF07	Mobile Intel(R) 945GM Express Chipset Family

4.2 Interrupt Request Lines (IRQ)

Peripheral devices use interrupt request lines to notify CPU for the service required. The following table shows the IRQ used by the devices on board.

Level	Function
IRQ 1	Standard 101/102-Key or Microsoft Natural PS/2 Keyboard
IRQ 3	Communications Port
IRQ 4	Communications Port
IRQ 6	Standard floppy disk controller
IRQ 8	System CMOS/real time clock
IRQ 9	Microsoft ACPI-Compliant System
IRQ 12	PS/2 Compatible Mouse
IRQ 14	Primary IDE Channel
IRQ 15	Secondary IDE Channel
IRQ 16	Intel(R) 82801G (ICH7 Family) USB Universal Host Controller - 27CB
IRQ 16	Intel(R) 82801G (ICH7 Family) PCI Express Root Port - 27D0
IRQ 16	Intel(R) 82945G Express Chipset Family
IRQ 18	Intel(R) 82801G (ICH7 Family) USB Universal Host Controller - 27CA
IRQ 19	Intel(R) 82801G (ICH7 Family) PCI Express Root Port - 27D6
IRQ 19	Intel(R) 82801G (ICH7 Family) USB Universal Host Controller - 27C9
IRQ 19	Realtek RTL8168/8111 PCI-E Gigabit Ethernet NIC
IRQ 23	Intel(R) 82801G (ICH7 Family) USB Universal Host Controller - 27C8
IRQ 23	Intel(R) 82801G (ICH7 Family) USB Universal Host Controller - 27CC

4.3 Memory Resources

Address	Device Description
D0000000 - FFFFFFFF	Mobile Intel(R) 945GM Express Chipset Family
FD900000 - D9FFFFFF	Intel(R) 82801G (ICH7 Family) PCI Express Root Port - 27D6
FDA00000 - DAFFFFFF	Intel(R) 82801G (ICH7 Family) PCI Express Root Port - 27D6
FDAFF000 - DAFFFFFF	Realtek RTL8168/8111 PCI-E Gigabit Ethernet NIC
FDAFF000 - DAFFFFFF	Realtek RTL8168/8111 PCI-E Gigabit Ethernet NIC
FDB00000 - FDBFFFFFF	Intel(R) 82801G (ICH7 Family) PCI Express Root Port - 27D0
FDE00000 - FDEFFFFFF	Intel(R) 82801G (ICH7 Family) PCI Express Root Port - 27D0
FDF00000 - FDF7FFFF	Mobile Intel(R) 945GM Express Chipset Family
FDF80000 - FDFBFFFF	Mobile Intel(R) 945GM Express Chipset Family
FDFFD000 - FDFFD0FF	Realtek AC'97 Audio
FDFFE000 - FDFFE1FF	Realtek AC'97 Audio
FDFFF000 - FDFFF3FF	Intel(R) 82801G (ICH7 Family) USB2 Enhanced Host Controller - 27CC
000A0000 - 000BFFFF	PCI bus
000A0000 - 000BFFFF	Mobile Intel(R) 945GM Express Chipset Family
000C0000 - 000DFFFF	PCI bus
1F700000 - FEBFFFFFF	PCI bus

